

# LINEAR GRILLES WITH HORIZONTAL FIXED BARS WITHOUT FRAME.



## Serie EBLF

Linear grilles with horizontal aluminium fixed bars with 0° or 15° deflection. Removable central core.

## CHARACTERISTICS

Material: aluminium.

Finish: anodized.

Installation: fastening with brackets;

## USE

Grilles used in air conditioning and ventilation systems for both supply and return.

## INSTALLATION

For flush installation for 12.5 mm thick plasterboard walls.

For flush installation for masonry walls.

## MODELS

EBLF20/0: with frame and front fixed bars with 0° deflection;

EBLF20/15: with frame and front fixed bars with 15° deflection;

## ACCESSORIES

- SC galvanised steel regulation damper with blades with opposing movement;

## ON DEMAND

Painting in different RAL colours.

## CODE

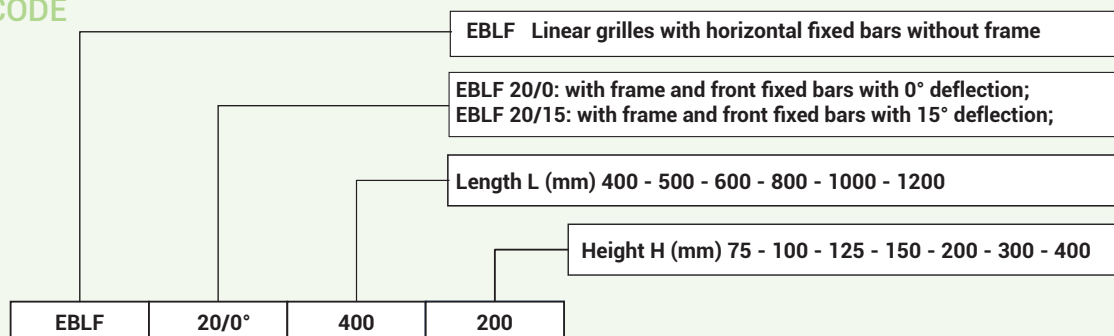

## EBLF 20/0° - 20/15° DIMENSIONS

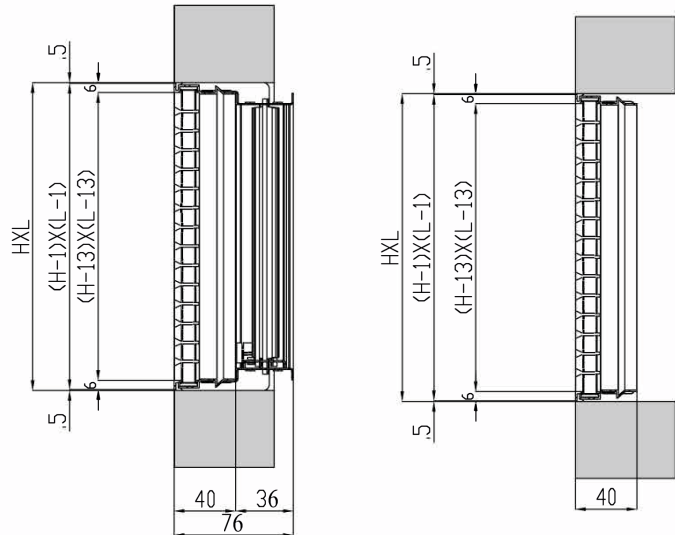

### DATI DI FUNZIONAMENTO:

dimensions LxH	effective cross- section m <sup>2</sup>	Vk 2 m/s		Vk 3 m/s		Vk 4 m/s	
		m <sup>3</sup> /h	L1	m <sup>3</sup> /h	L1	m <sup>3</sup> /h	L1
		400x75	0,015	108	2,4	160	3,6
500x75	0,019	197	2,5	201	3,8	268	5,1
600x75	0,022	158	2,6	243	3,9	323	5,2
800x75	0,030	216	2,8	326	4,2	434	5,6
1000x75	0,038	274	2,9	408	4,4	545	5,8
1200x75	0,046	331	3	497	4,5	662	6
400x100	0,020	144	2,6	216	3,8	292	5,1
500x100	0,026	230	3,3	276	4,1	367	5,4
600x100	0,031	281	3,5	332	4,2	443	5,6
800x100	0,041	374	3,8	446	4,4	595	5,9
1000x100	0,052	475	3,9	560	4,7	746	6,2
1200x100	0,062	590	2,6	670	4,8	893	6,4
400x125	0,026	187	2,7	278	4,1	370	5,4
500x125	0,032	230	2,8	350	4,2	467	5,6
600x125	0,039	281	2,9	422	4,4	563	5,9
800x125	0,052	374	3,1	566	4,7	755	6,2
1000x125	0,066	475	3,3	711	4,9	947	6,5
1200x125	0,082	590	3,4	886	5,1	1149	6,9
400x150	0,031	223	2,8	337	4,2	449	5,6
500x150	0,039	281	2,9	424	4,4	566	5,9
600x150	0,047	338	3	512	4,6	682	6,1
Pa		3		7		12	
dB(A)		15/20		28/32		38 / 42	

Vk: velocità efficace (m/s)

m<sup>3</sup>/h: portata

Pa: perdite di carico in Pascal

L1 (m): lancio riferito ad una velocità terminale Vt= 0,25 m/s montati in prossimità del soffitto (con altezza dal pavimento non superiore ai 3 m); per distanze superiori correggere il lancio moltiplicandolo x 0,7

dB(A): indice di rumorosità

Tutte le dimensioni sono espresse in mm.

dimensions LxH	effective cross- section	Vk 2 m/s		Vk 3 m/s		Vk 4 m/s	
		m <sup>3</sup> /h	L1	m <sup>3</sup> /h	L1	m <sup>3</sup> /h	L1
	m <sup>2</sup>						
800x150	0,064	461	3,2	687	4,9	916	6,5
1000x150	0,080	576	3,4	862	5,1	1149	6,8
1200x150	0,096	691	3,5	1037	5,2	1382	7
400x200	0,042	302	3	455	4,5	607	6
500x200	0,053	380	3,1	573	4,7	764	6,2
600x200	0,064	461	3,2	691	4,9	922	6,5
800x200	0,086	619	3,4	927	5,2	1237	6,9
1000x200	0,108	778	3,6	1164	5,4	1552	7,2
1200x200	0,130	936	3,7	1404	5,6	1872	7,4
400x300	0,064	461	3,2	691	4,9	922	6,3
500x300	0,081	583	3,3	875	5,1	1166	6,6
600x300	0,097	698	3,5	1050	5,3	1400	7
800x300	0,130	936	3,7	1409	5,6	1879	7,5
1000x300	0,164	1181	3,9	1768	5,9	2357	7,8
1200x300	0,198	1426	4,1	2138	6,2	2851	8,3
400x400	0,084	603	3,4	904	5,1	1205	6,9
500x400	0,105	753	3,6	1130	5,4	1507	7,2
600x400	0,126	904	3,7	1356	5,6	1808	7,4
800x400	0,167	1205	3,9	1808	5,9	2411	7,9
1000x400	0,209	1507	4,1	2260	6,2	3013	8,2
1200x400	0,251	1808	7,1	2712	6,4	3616	8,5
Pa		3		7		12	
dB(A)		15/20		28/32		38 / 42	

Vk: velocità efficace (m/s)

m<sup>3</sup>/h: portata

Pa: perdite di carico in Pascal

L1 (m): lancio riferito ad una velocità terminale  
Vt= 0,25 m/s montati in prossimità del soffitto  
(con altezza dal pavimento non superiore ai 3  
m); per distanze superiori correggere il lancio  
moltiplicandolo x 0,7

dB(A): indice di rumorosità

Tutte le dimensioni sono espresse in mm.

# EBLF 20/0° EBLF 20/15° DIMENSIONS WITH AND WITHOUT DAMPER ON MASONRY WALL

For installation you need the fixing kit consisting of 4 brackets, not supplied with the article.  
 N.B. for installation on a masonry wall, the heights 75 mm, 100 mm are not available.

Deflessione 0° / Deflection 0°



Deflessione 15° / Deflection 15°

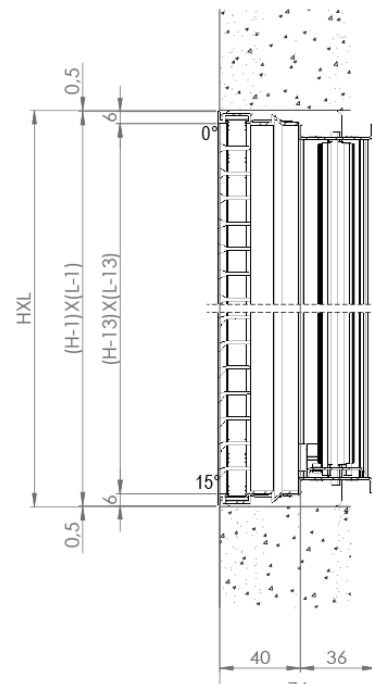
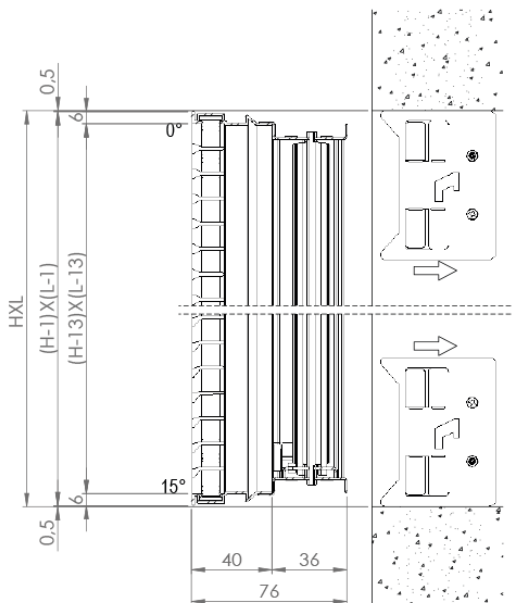
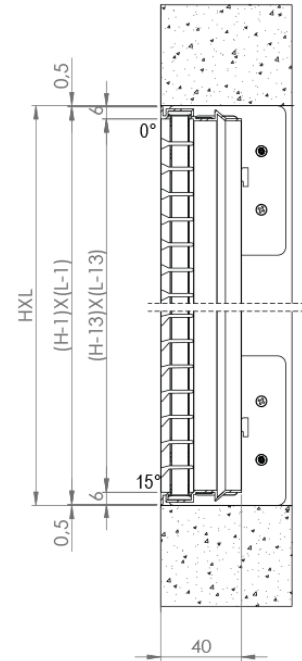
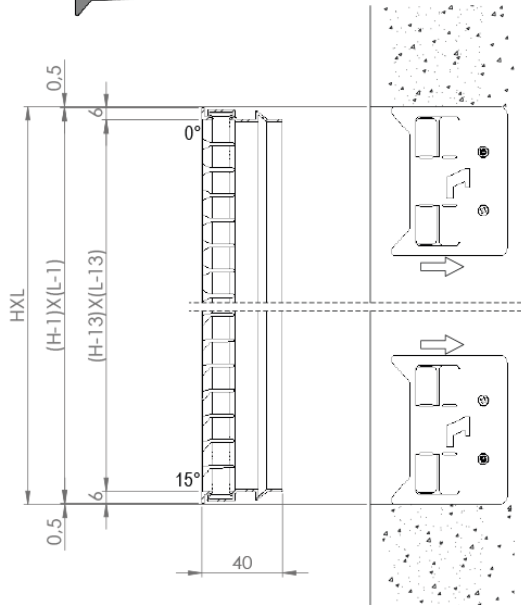

# EBLF 20/0° EBLF 20/15° DIMENSIONS WITH AND WITHOUT DAMPER ON PLASTERBOARD WALL

For installation you need the fixing kit consisting of 4 brackets, not supplied with the article.

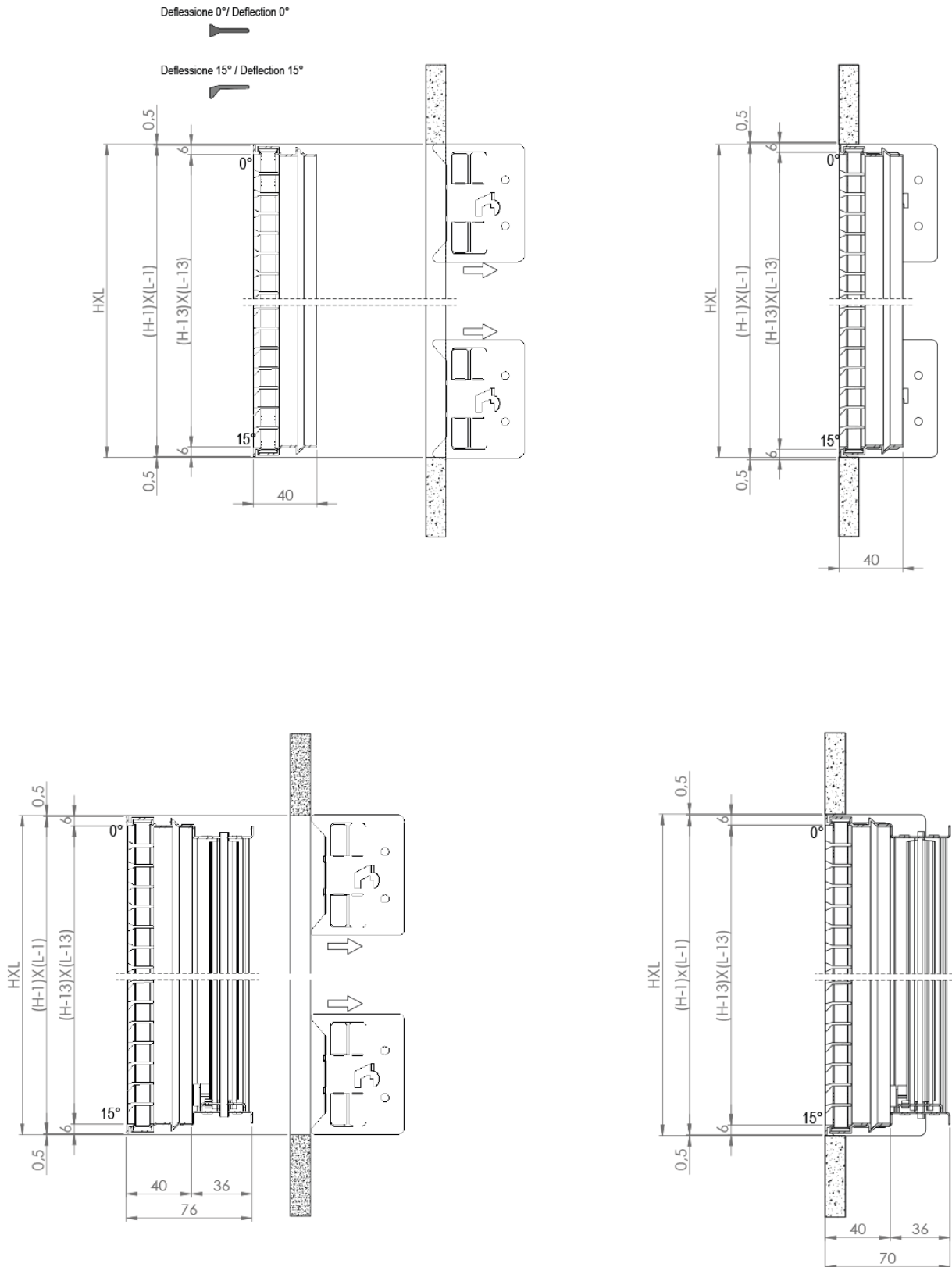

## SC CALIBRATION DAMPER

- Galvanised steel regulation damper with blades with opposing movement.
- Maximum dimensions L x H for construction in one piece 1000 mm x 600 mm.

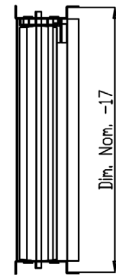
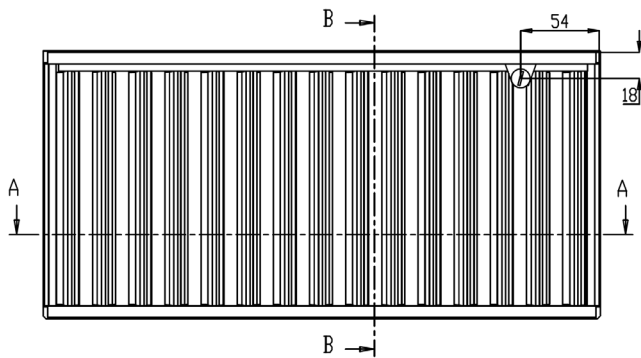
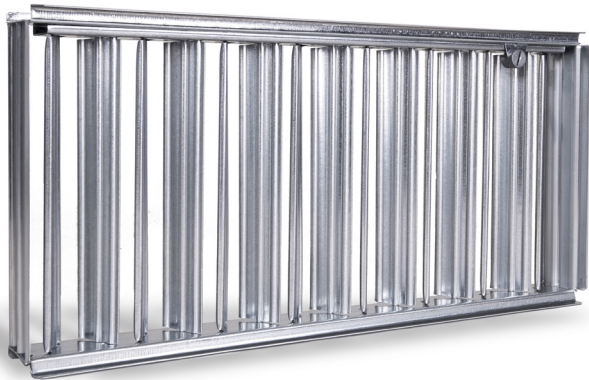

SEZIONE B-B

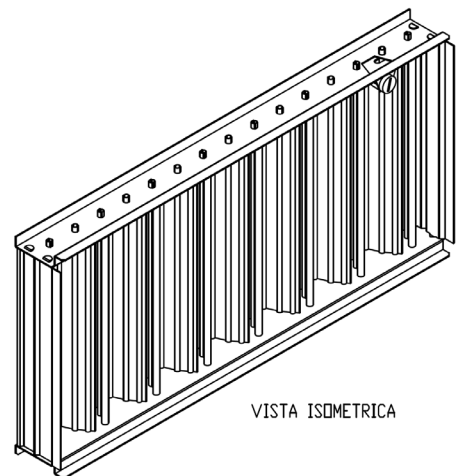
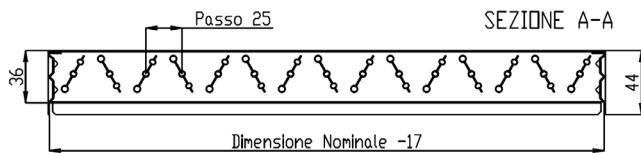

VISTA ISOMETRICA

## ASSEMBLY INSTRUCTION OF THE PLATE KIT ON MASONRY WALL

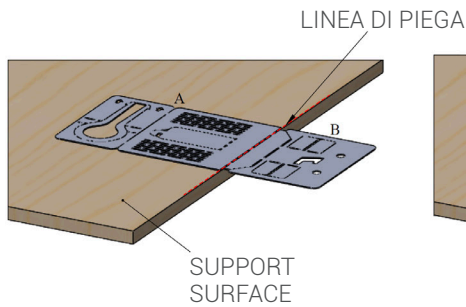

STEP 1- LAY THE SURFACE "A" OF THE PLATE ON A FLAT SURFACE, LEAVING SURFACE "B" PROTRUDING

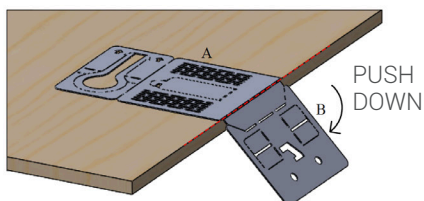

STEP 2- KEEPING SURFACE "A" ADHERED TO THE FLAT SURFACE, PUSH DOWN "B" SURFACE UNTIL A 90-DEGREE FOLD IS OBTAIN

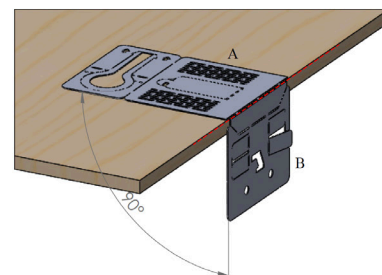

STEP 3- LIFT UP THE FLAP/S

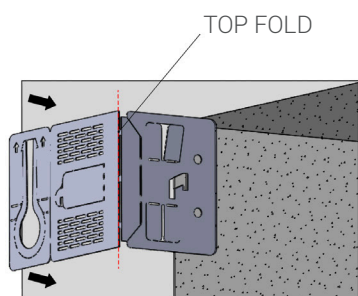

STEP 4- LAY THE PLATE MATCHING THE ANGLE OF IT WITH THE ANGLE OF THE WALL HOLE

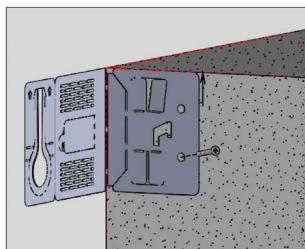

STEP 5- DRILL THE MASONRY AND FASTEN THE PLATE WITH SCREW/S AND DOWEL/S TO BE PLACED AS IN THE PICTURE

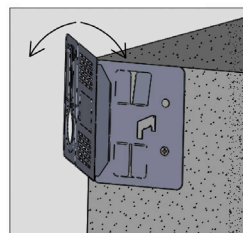

STEP 6 - REMOVING THE EXCEEDING OF PART OF THE PLATE SWINGING IT UNTIL IT IS COMPLETELY REMOVED

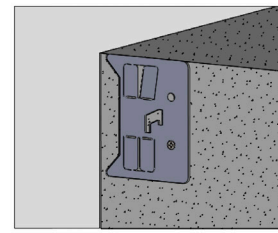
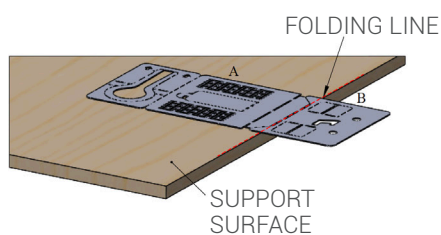
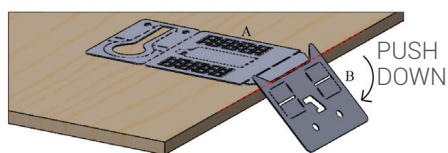

PLATE FINAL RESULT

## ASSEMBLY INSTRUCTION OF THE PLATE KIT ON PLATERBOARD WALL



STEP 1 - LAY THE SURFACE "A" OF THE PLATE ON A FLAT SURFACE, LEAVING SURFACE "B" PROTRUDING



STEP 2- KEEPING SURFACE "A" ADHERED TO THE PLANE, PUSH DOWN "B" SURFACE UNTIL A 90-DEGREE FOLD IS OBTAIN

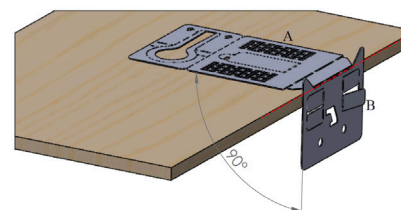

STEP 3- LIFT UP THE FLAP/S AS SHOWN IN THE DRAWING AT TABLE 3

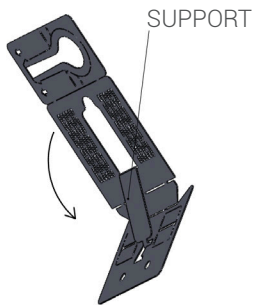

STEP 4- ROTATE THE SUPPORT UNTIL THE HOOK IS INSERT INSIDE THE GAP

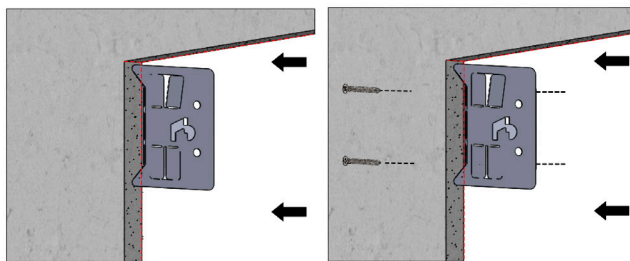

STEP 6- POSITION THE PLATE ON THE INSIDE OF THE PLASTERBOARD WALL AS IN THE PICTURE

STEP 7- FASTEN THE SCREWS INTO THE DRYWALL PLATE UNTIL THE SLOTTED HOLES IN THE PLATE ARE REACHED

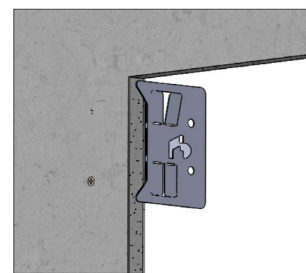
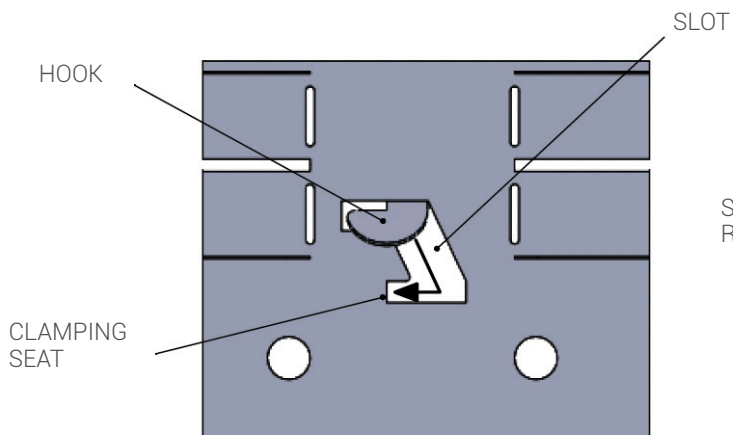
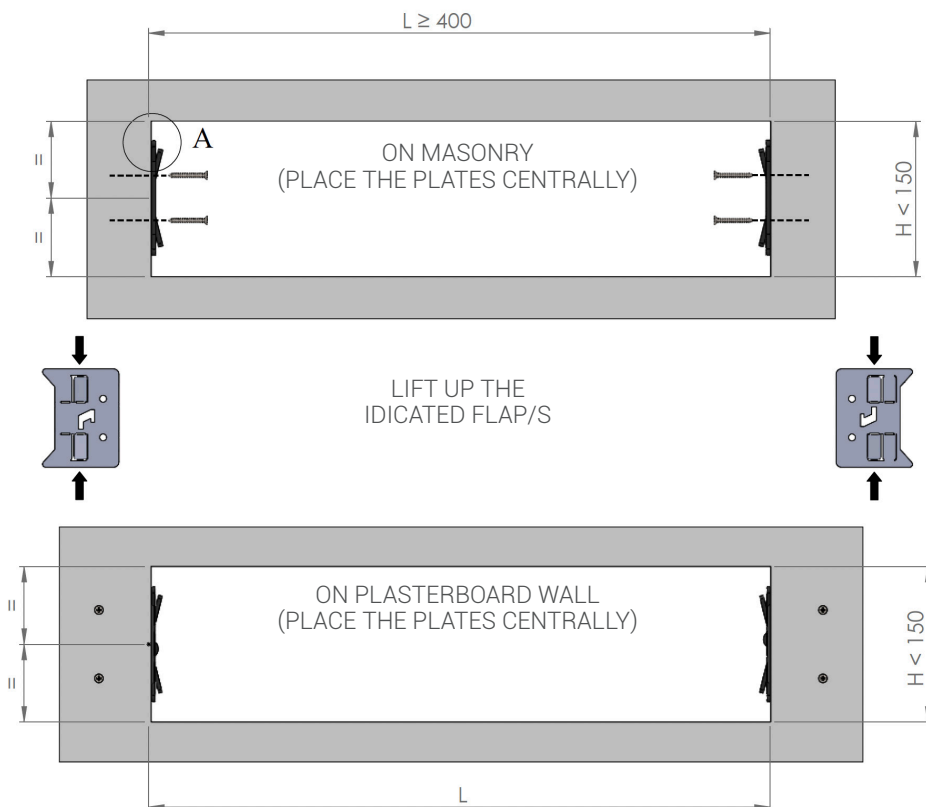

PLATE FINAL RESULT



STEP 5- SLIDE THE HOOK INSIDE THE SPLIT UNTIL IT REACHES THE LOCKING SEAT

### POSITION OF THE PLATE KIT H<150





## POSITION OF THE PLATE KIT H>150

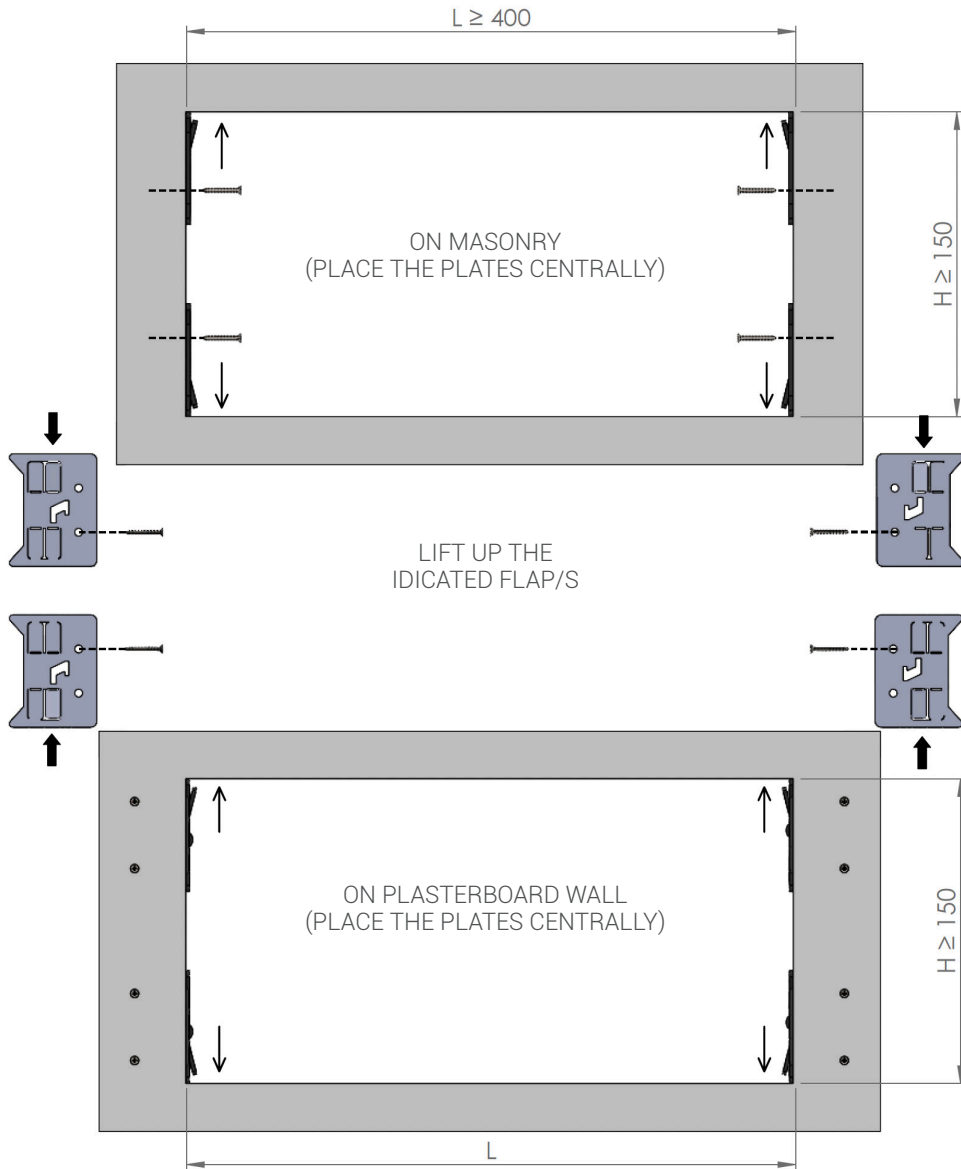

DETAIL A

4/5 mm Max.

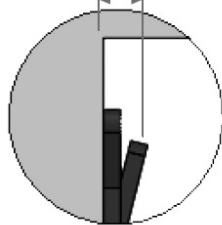

LIFT UP THE FLAP/S AS SHOWN IN DETAIL A

## EBLF MOUNTING INSTRUCTIONS ON MASONRY WALLS

In case of installation on a masonry wall, after the space for the grille installation has been created, the hole will have to be duly grouted with concrete to allow the subsequent installation, and fixing with screws, of the fixing brackets.

The brackets can be installed either vertically or horizontally, thanks to the fixing profile that is continuously present on the entire side of the grille.  
N.B. for installation on a masonry wall, the heights 75 mm, 100 mm are not available.

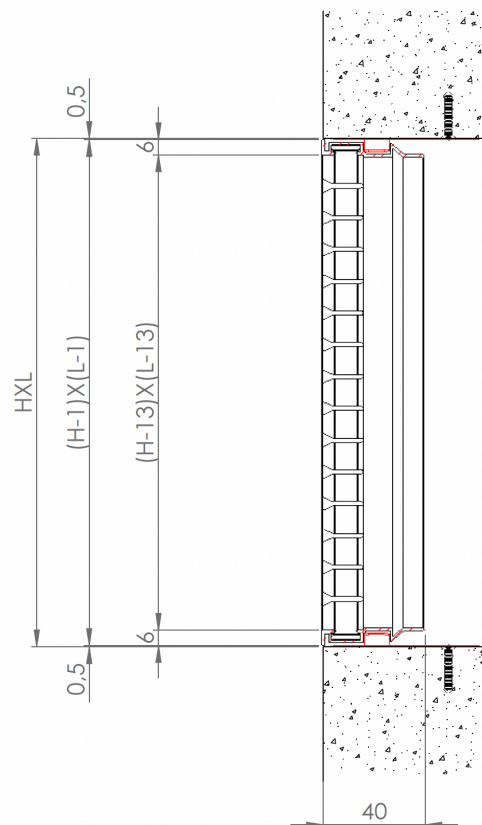
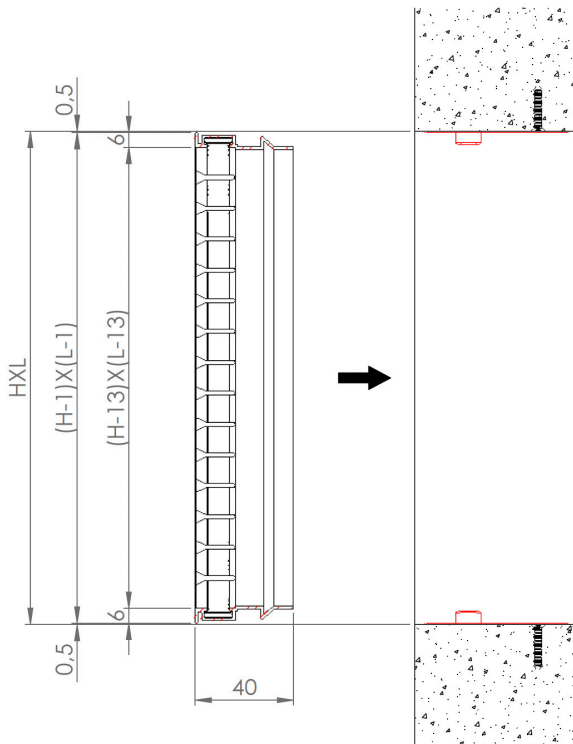
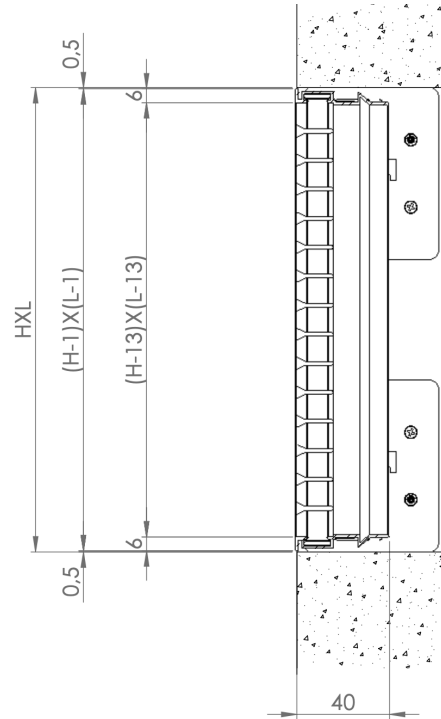
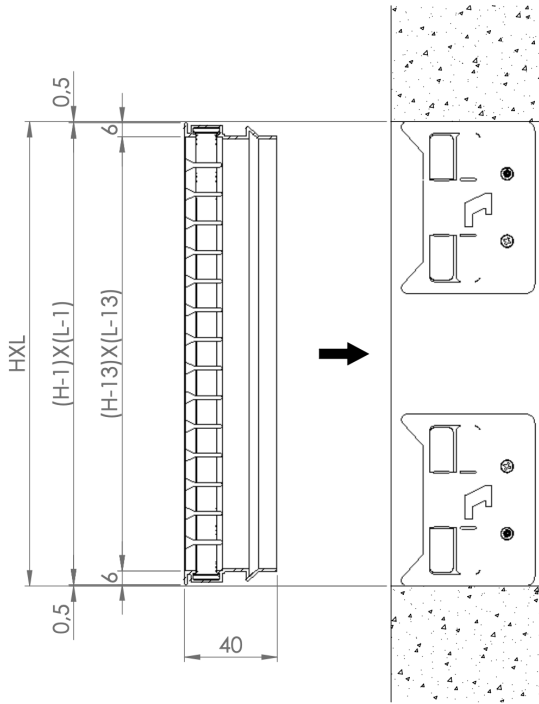
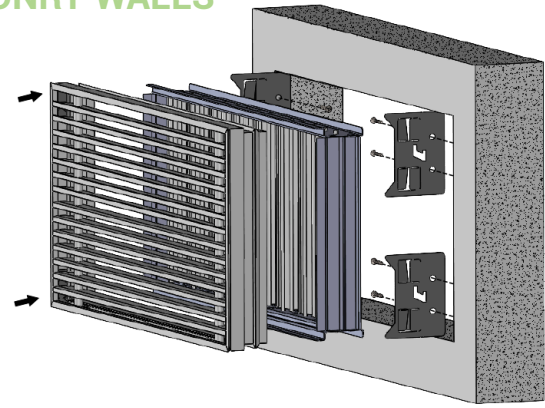

## EBLF MOUNTING INSTRUCTIONS ON PLASTERBOARD WALLS

In case of installation on a plasterboard wall, the brackets should be positioned, as can be seen in the drawing, at the rear of the wall and secured with screws. The brackets can be installed either vertically or horizontally, thanks to the fixing profile present continuously on the entire side of the grille.

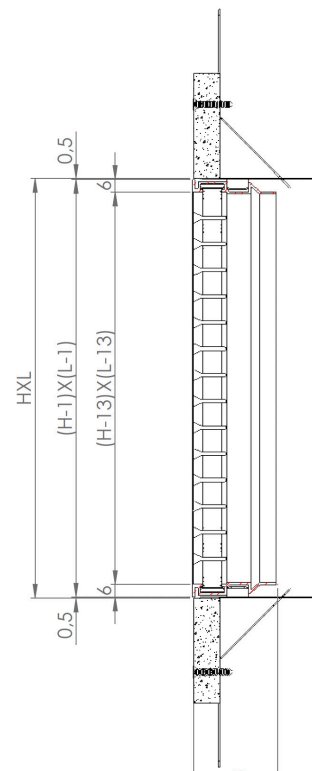
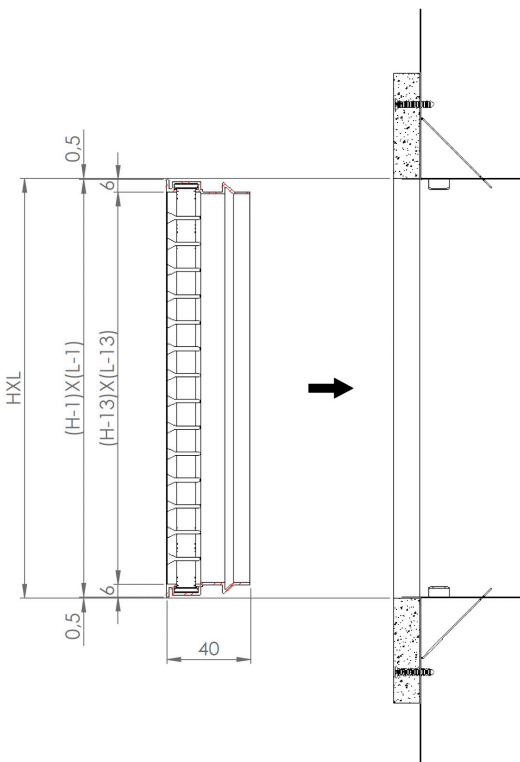
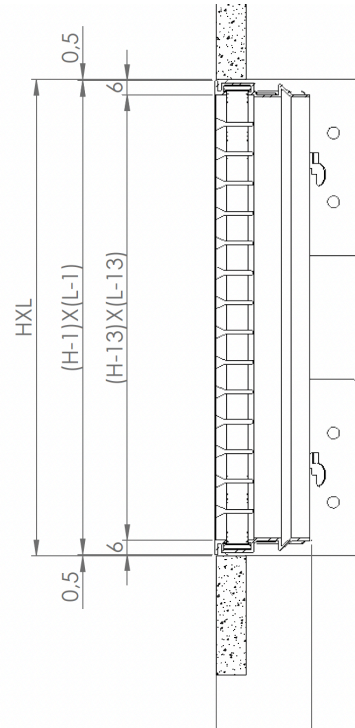
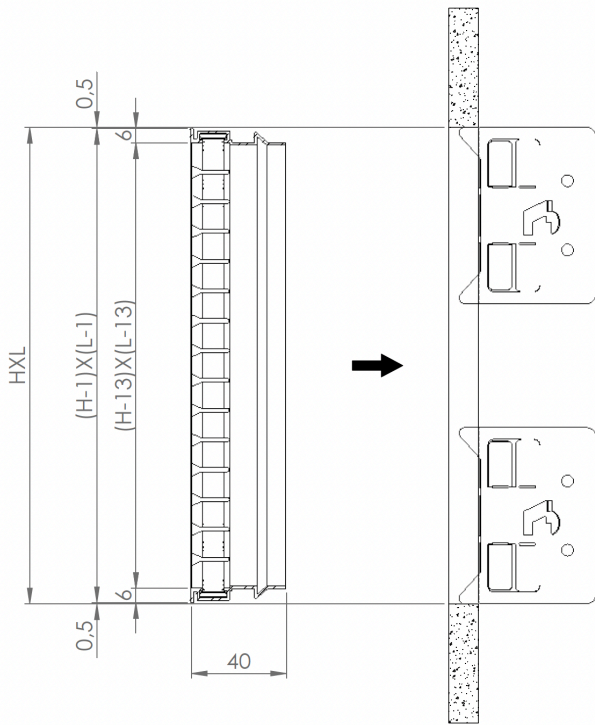
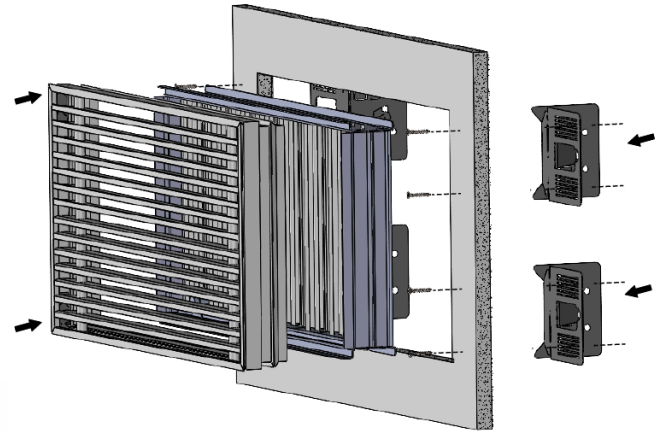

## PLATE FOR AIR JET REMOVAL

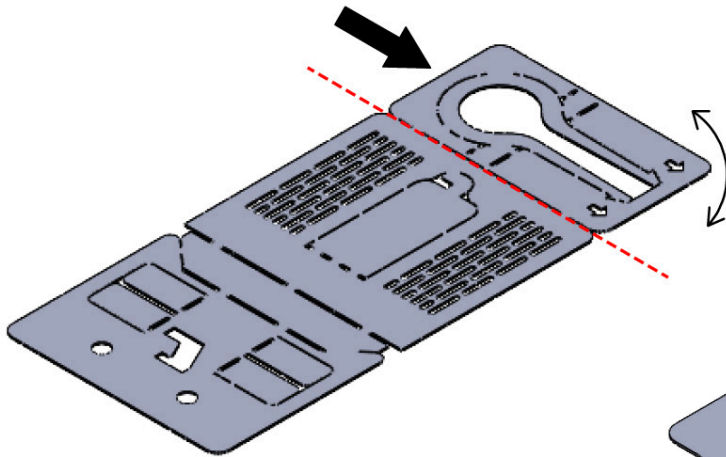

STEP 1 - REMOVING THE INDICATED PART SWINGING IT UNTIL IT IS COMPLETELY REMOVED

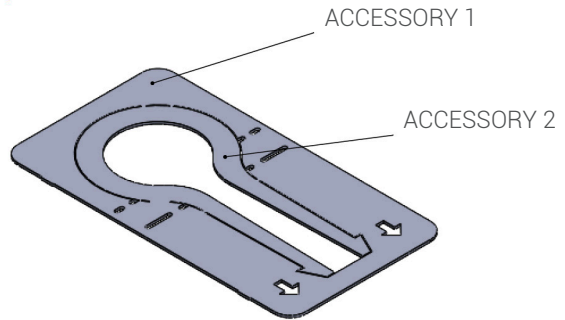

STEP 2 - PRESS ON THE INDICATED PART UNTIL THE TWO ACCESSORIES ARE SEPARATED

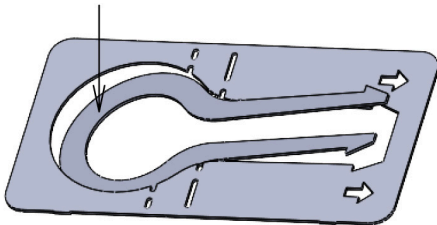

ACCESSORY 1  
- FOR UNLOCKING THE FLAPS ON THE PLATE

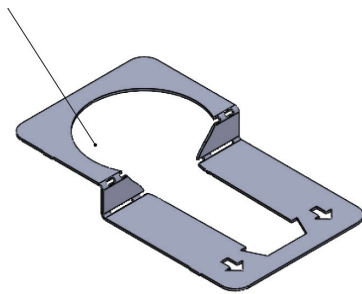

ACCESSORY 2  
- FOR THE REMOVAL OF THE GRILLES / AIR JET ON THE WALL

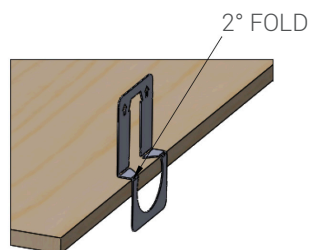
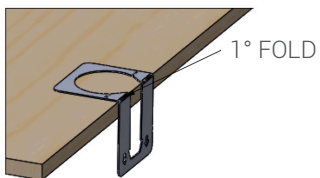
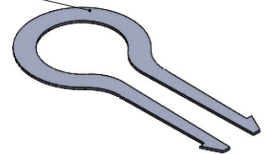

## AIR JET REMOVAL

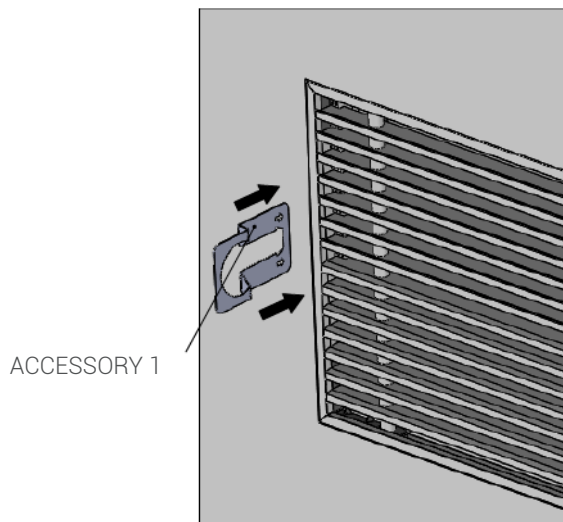

STEP 1- INSERT ACCESSORY 1 Laterally between grille and wall, until the folded part is flat

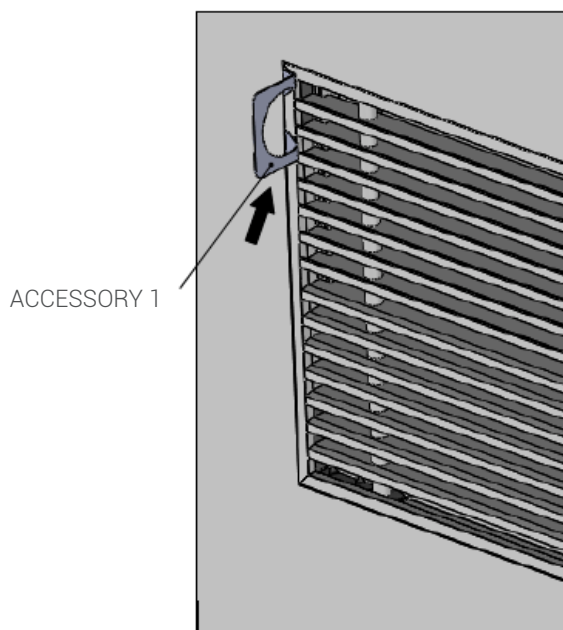

STEP 2- SLIDE ACCESSORY 1 upwards until the upper part of the grille is released

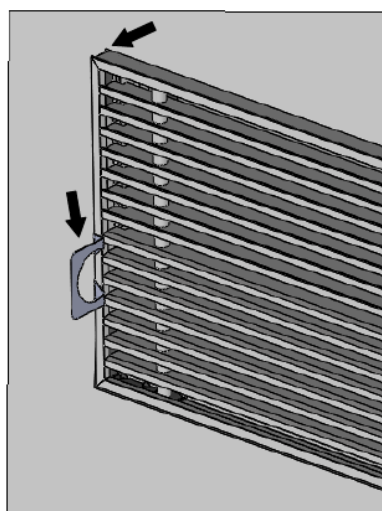

STEP 3- SLIDE THE ACCESSORY downwards until the nozzle is completely disengaged

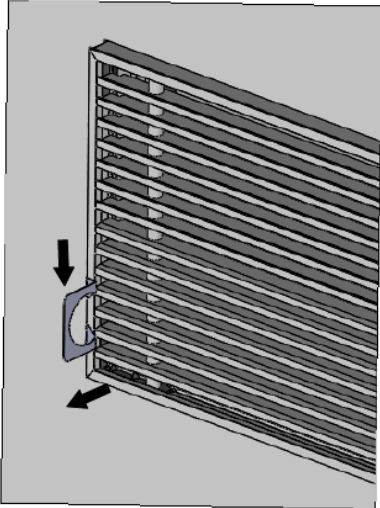

STEP 4- REMOVE THE GRILLE FROM THE MOUNTING PLATES

