

INCLINED SQUARE MESH GRILLES WITHOUT FRAME

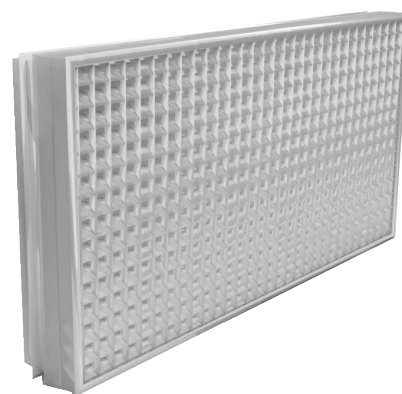

Series EGQIF

Aluminium exhaust grilles with inclined square mesh grilles, pitch 13x13 mm.

CHARACTERISTICS

Material: aluminium, perimeter frame.

Finish: natural anodised

Installation: fastening with brackets;

USE

Its nice design and large effective cross-section make it ideal for civil installations:

- For air exhaust in rooms.
- For flush installation for 12.5 mm thick plasterboard walls.
- For flush installation for masonry walls.
- For extraction and supply on fan coil cabinet.

ACCESSORIES

- SC galvanised steel regulation damper with blades with opposing movement;

ON DEMAND

Painting in different RAL colours.

CODE

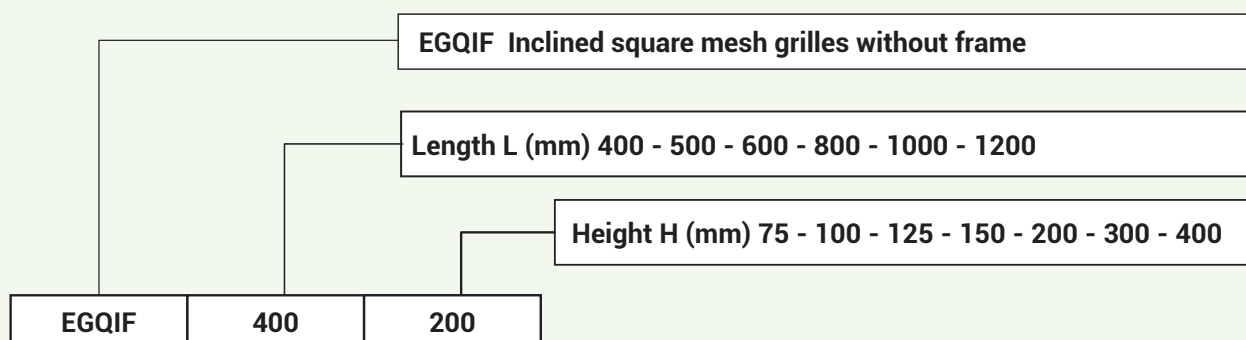

EFFECTIVE CROSS-SECTION

H	L					
	400	500	600	800	1000	1200
Effective cross-section m ²						
75	0,022	0,029	0,035	0,046	0,059	0,070
100	0,032	0,041	0,050	0,066	0,084	0,100
125	0,046	0,059	0,071	0,095	0,120	0,144
150	0,051	0,065	0,077	0,101	0,132	0,158
200	0,070	0,088	0,108	0,143	0,181	0,217
300	0,107	0,137	0,166	0,221	0,271	0,334
400	0,139	0,179	0,217	0,288	0,365	0,436

OPERATING DATA

H	Vk m/s	L							
		400	500	600	800	1000	1200		
Flow rate m ³ /h									
75	1	81	103	125	167	212	254	2	<15
	3	242	309	376	502	635	761	7	28/32
	5	323	412	502	669	847	1014	12	38/42
100	1	120	150	180	240	305	360	2	<15
	3	350	445	540	715	905	1080	7	28/32
	5	465	590	715	955	1205	1440	12	38/42
125	1	167	212	257	342	433	518	2	<15
	3	500	636	772	1027	1299	1554	7	28/32
	5	666	847	1029	1369	1732	2072	12	38/42
150	1	183	233	276	362	477	571	2	<15
	3	550	700	827	1086	1431	1712	7	28/32
	5	734	934	1103	1448	1908	2282	12	38/42
200	1	251	318	388	516	653	781	2	<15
	3	754	953	1164	1549	1959	2344	7	28/32
	5	1005	1270	1552	2065	2612	3125	12	38/42
300	1	387	492	597	795	975	1203	2	<15
	3	1161	1476	1792	2384	2926	3608	7	28/32
	5	1547	1968	2389	3179	3901	4810	12	38/42
400	1	502	643	781	1038	1313	1571	2	<15
	3	1516	1928	2342	3115	3946	4714	7	28/32
	5	2008	2572	3122	4153	5254	6285	12	38/42

Vk: effective speed (m/s)
m³/h: flow rate
Pa: pressure drops in Pascal
dB(A): noise level

L: base
H: height
All dimensions are expressed in mm.

EGQIF DIMENSIONS WITH AND WITHOUT DAMPER ON MASONRY WALL

For installation you need the fixing kit consisting of 4 brackets, not supplied with the article.
 N.B. for installation on a masonry wall, the heights 75 mm, 100 mm are not available.

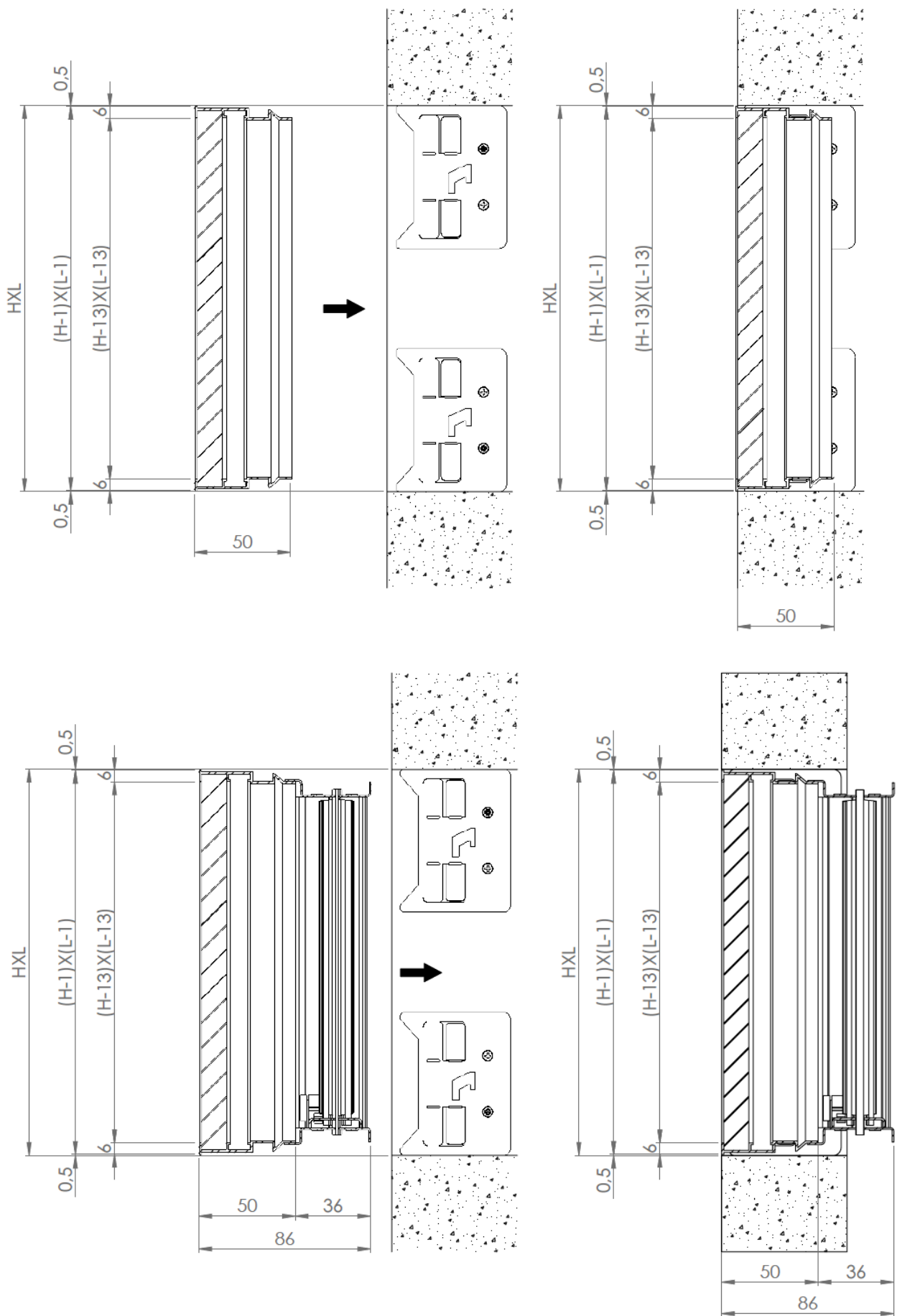

EGQIF DIMENSIONS WITH AND WITHOUT DAMPER ON PLASTERBOARD WALL

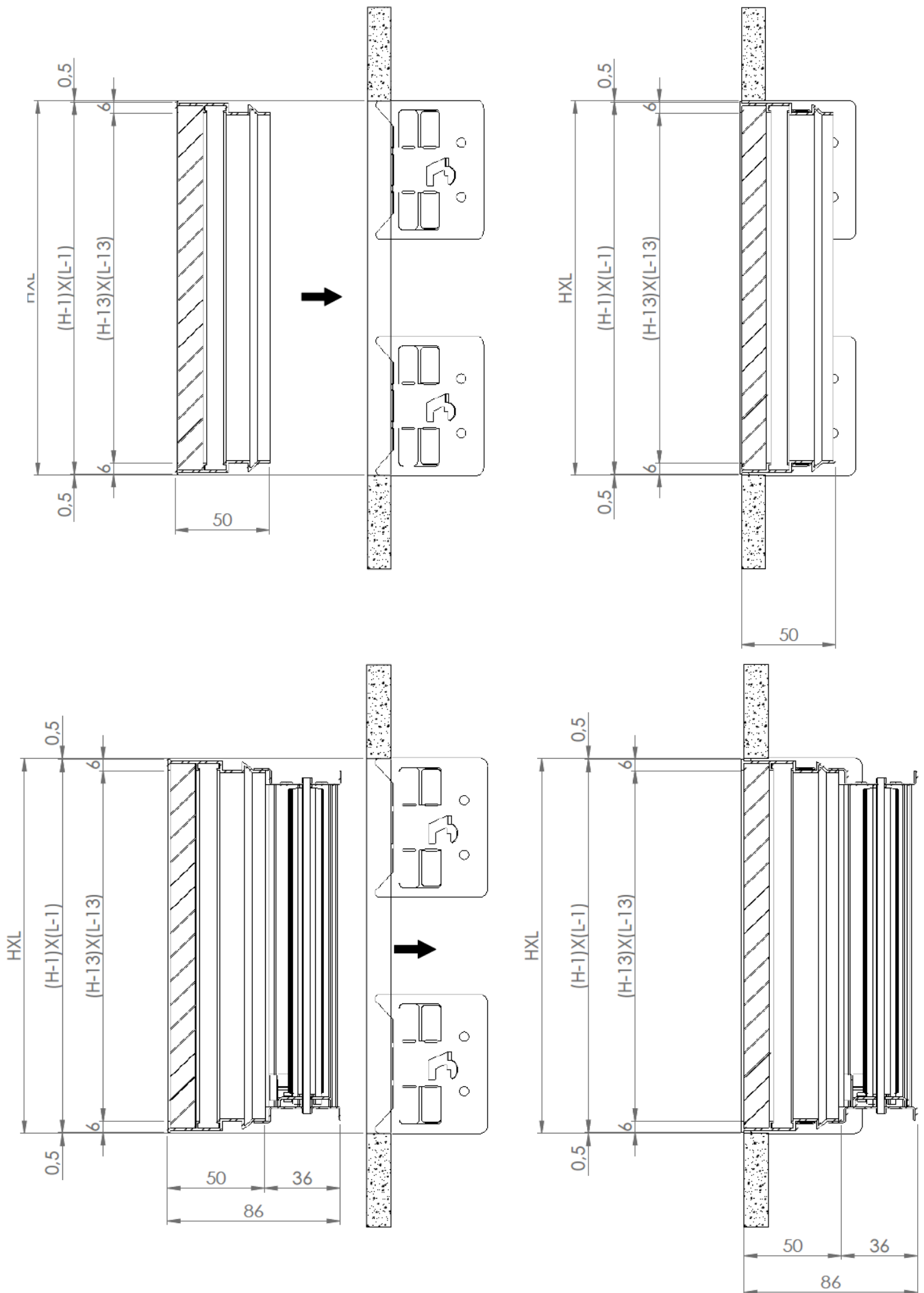

SC CALIBRATION DAMPER

- Galvanised steel regulation damper with blades with opposing movement.
- Maximum dimensions L x H for construction in one piece 1000 mm x 600 mm.

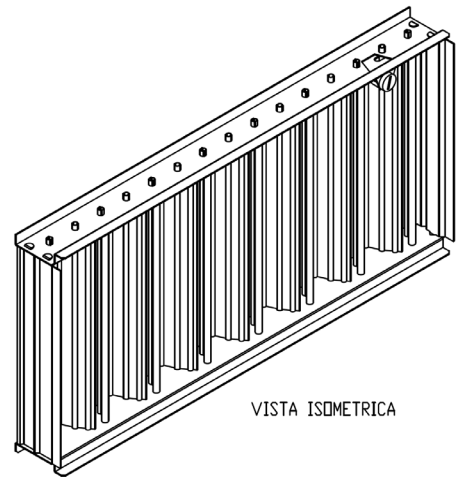
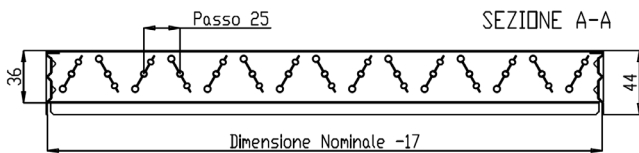
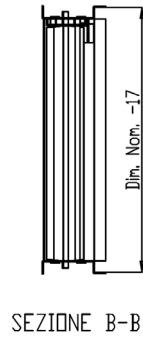
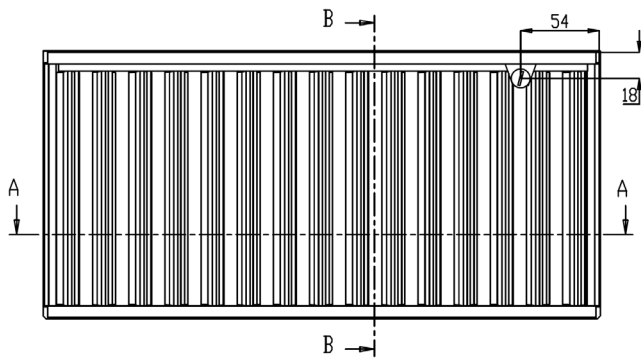
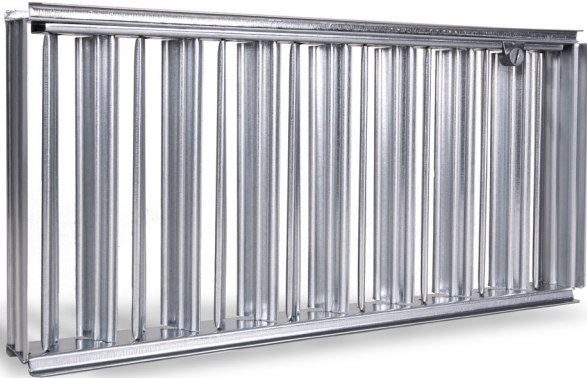

ASSEMBLY INSTRUCTION OF THE PLATE KIT ON MASONRY WALL

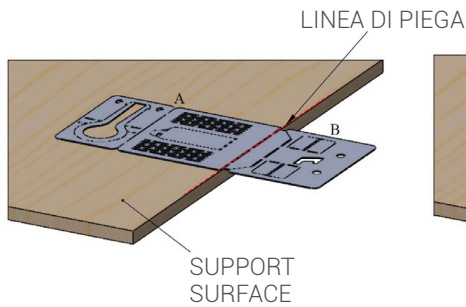

STEP 1- LAY THE SURFACE "A" OF THE PLATE ON A FLAT SURFACE, LEAVING SURFACE "B" PROTRUDING

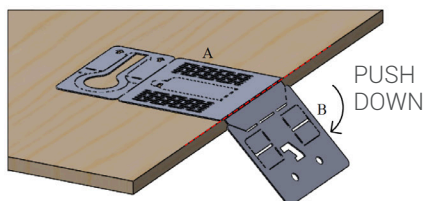

STEP 2- KEEPING SURFACE "A" ADHERED TO THE FLAT SURFACE, PUSH DOWN "B" SURFACE UNTIL A 90-DEGREE FOLD IS OBTAIN

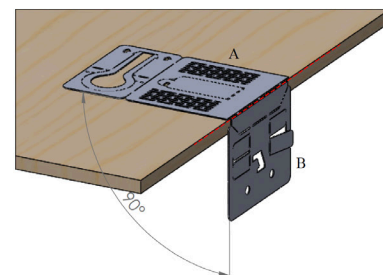

STEP 3- LIFT UP THE FLAP/S

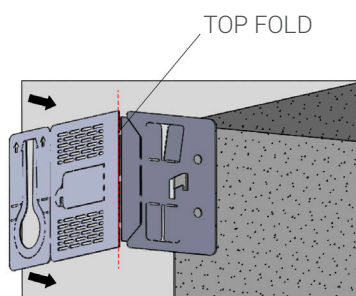

STEP 4- LAY THE PLATE MATCHING THE ANGLE OF IT WITH THE ANGLE OF THE WALL HOLE

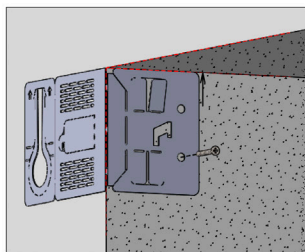

STEP 5- DRILL THE MASONRY AND FASTEN THE PLATE WITH SCREW/S AND DOWEL/S TO BE PLACED AS IN THE PICTURE

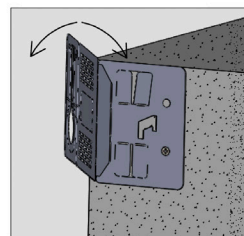

STEP 6 - REMOVING THE EXCEEDING OF PART OF THE PLATE SWINGING IT UNTIL IT IS COMPLETELY REMOVED

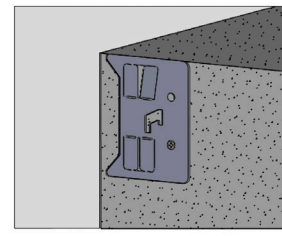
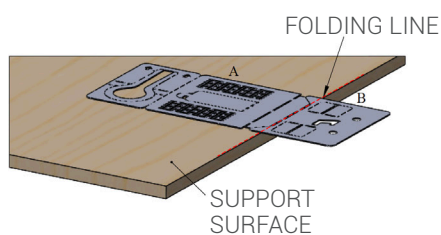
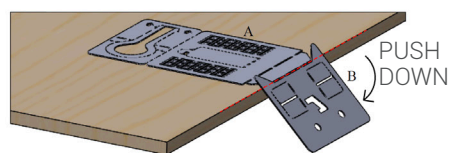

PLATE FINAL RESULT

ASSEMBLY INSTRUCTION OF THE PLATE KIT ON PLATERBOARD WALL



STEP 1 - LAY THE SURFACE "A" OF THE PLATE ON A FLAT SURFACE, LEAVING SURFACE "B" PROTRUDING



STEP 2- KEEPING SURFACE "A" ADHERED TO THE PLANE, PUSH DOWN "B" SURFACE UNTIL A 90-DEGREE FOLD IS OBTAIN

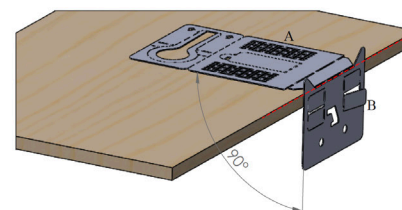

STEP 3- LIFT UP THE FLAP/S AS SHOWN IN THE DRAWING AT TABLE 3

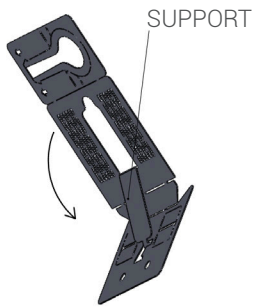

STEP 4- ROTATE THE SUPPORT UNTIL THE HOOK IS INSERT INSIDE THE GAP

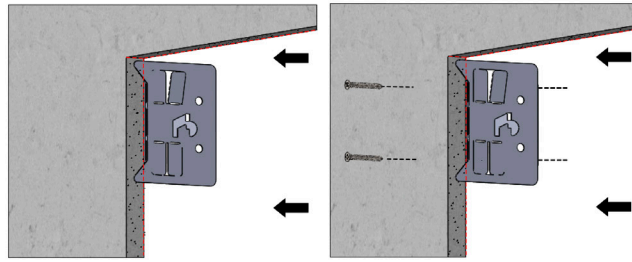

STEP 6- POSITION THE PLATE ON THE INSIDE OF THE PLASTERBOARD WALL AS IN THE PICTURE

STEP 7- FASTEN THE SCREWS INTO THE DRYWALL PLATE UNTIL THE SLOTTED HOLES IN THE PLATE ARE REACHED

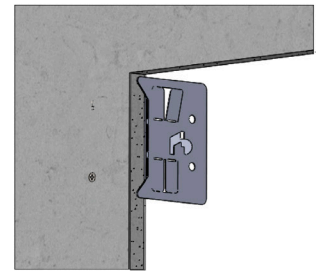
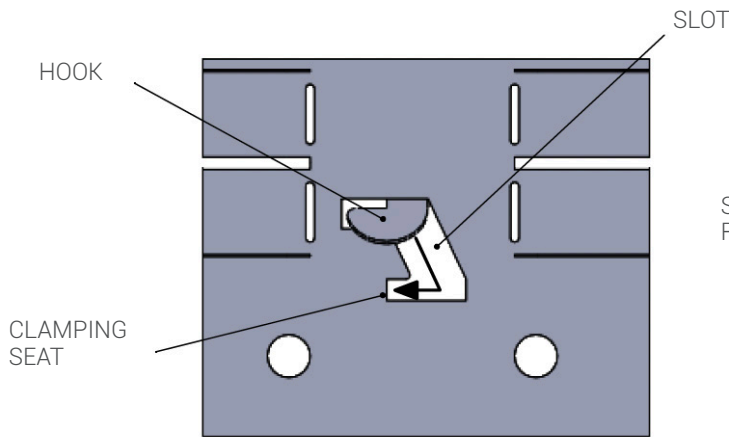
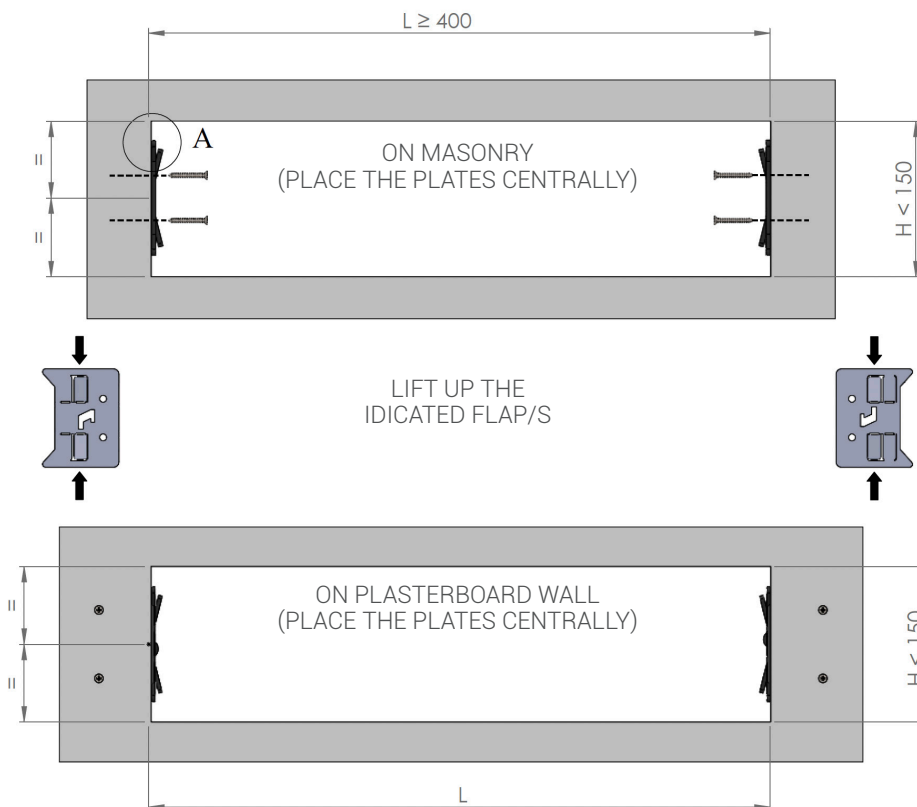

PLATE FINAL RESULT



STEP 5- SLIDE THE HOOK INSIDE THE SPLIT UNTIL IT REACHES THE LOCKING SEAT

POSITION OF THE PLATE KIT H<150



POSITION OF THE PLATE KIT H>150

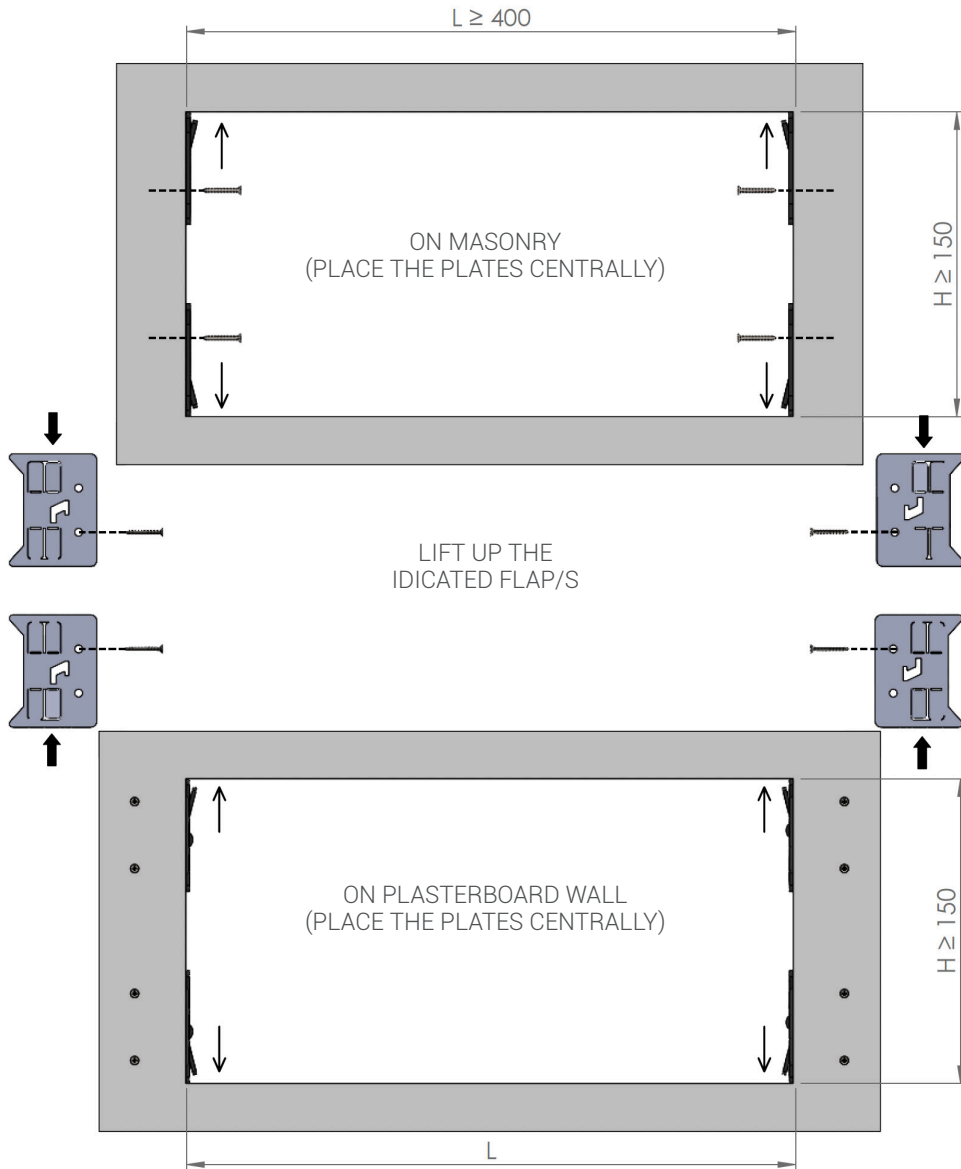

DETAIL A

4/5 mm Max.

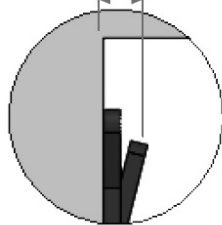

LIFT UP THE FLAP/S AS SHOWN IN DETAIL A

EGQIF MOUNTING INSTRUCTIONS ON MASONRY WALLS

In the case of installation on a masonry wall, after the space for the grille installation has been created, the hole will have to be duly grouted with concrete to allow the subsequent installation, and fixing with screws, of the fixing brackets.

The brackets can be installed either vertically or horizontally, thanks to the fixing profile that is continuously present on the entire side of the grille.

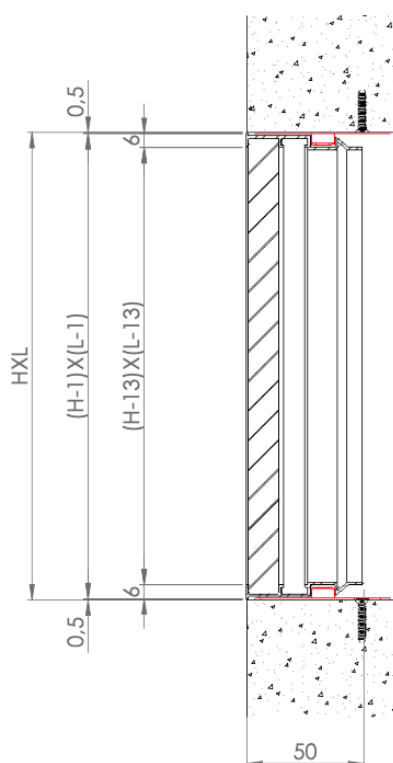
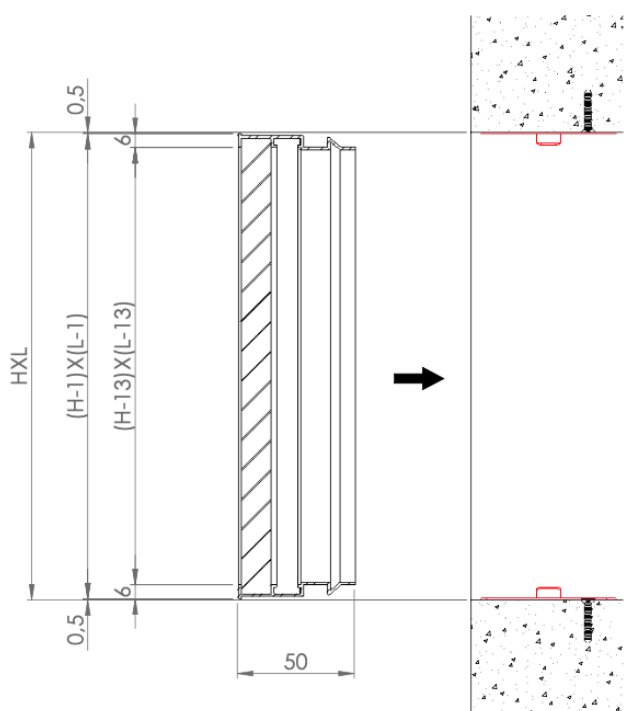
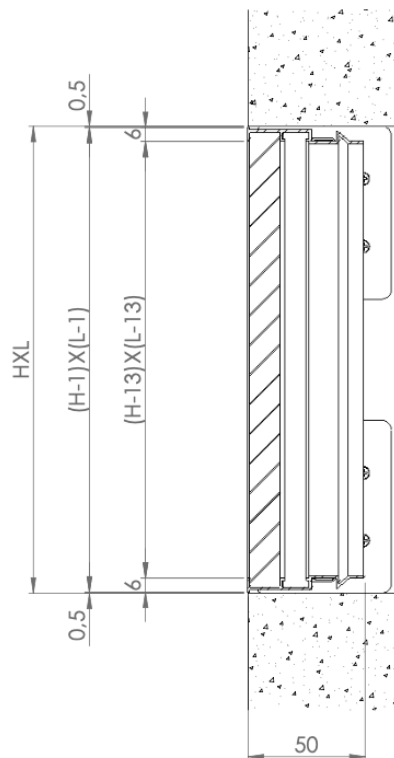
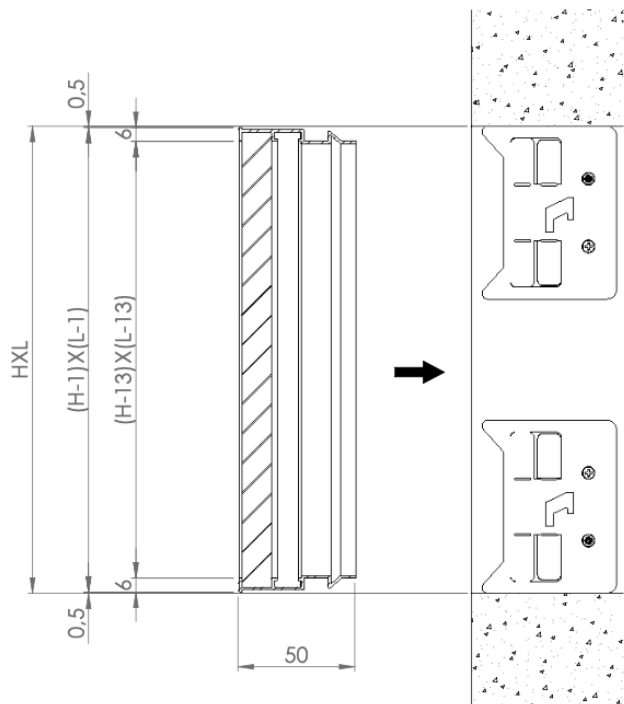
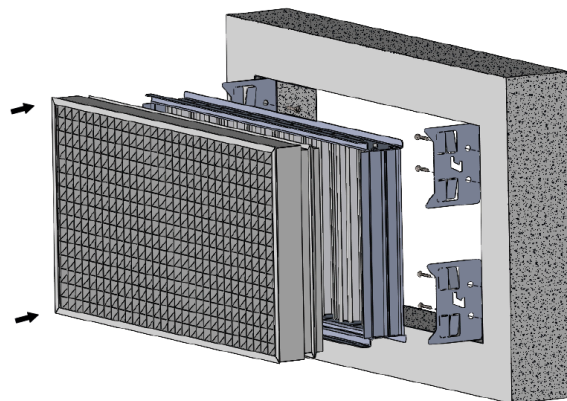

EGQIF MOUNTING INSTRUCTIONS ON PLASTERBOARD WALLS

In case of installation on a plasterboard wall, the brackets should be positioned, as can be seen in the drawing, at the rear of the wall and secured with screws. The brackets can be installed either vertically or horizontally, thanks to the fixing profile present continuously on the entire side of the grille.

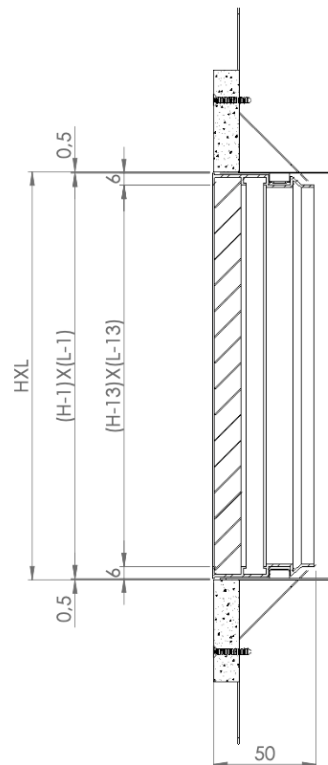
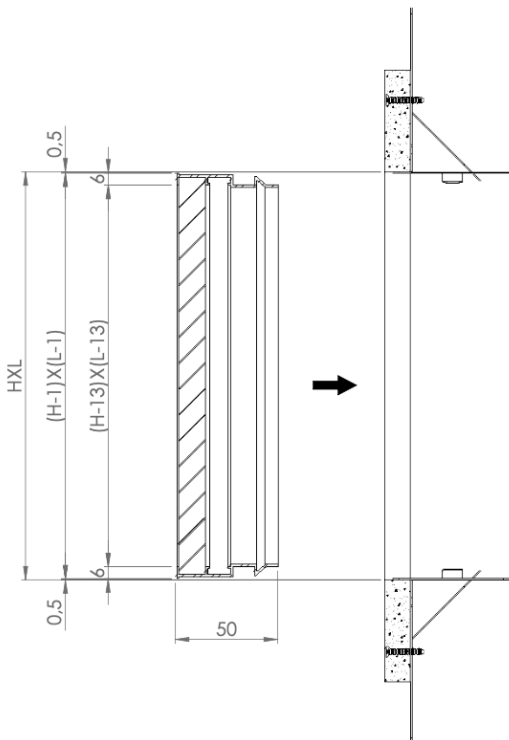
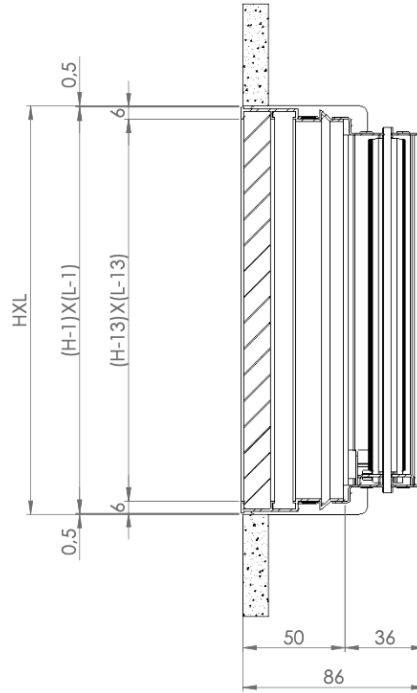
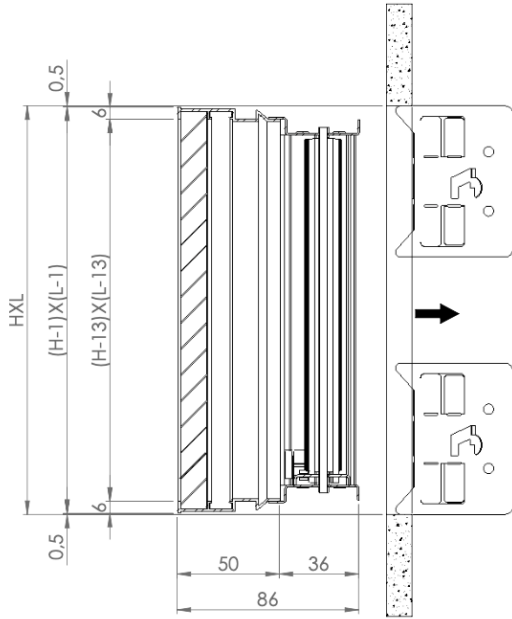
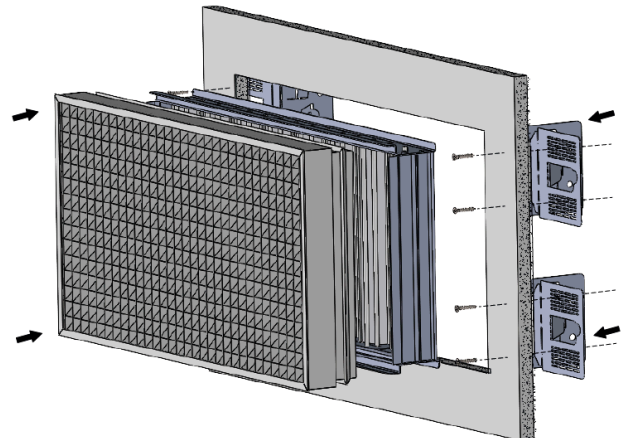
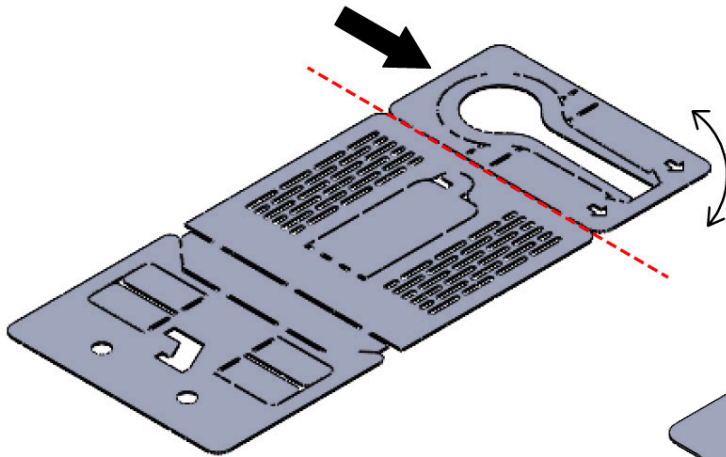
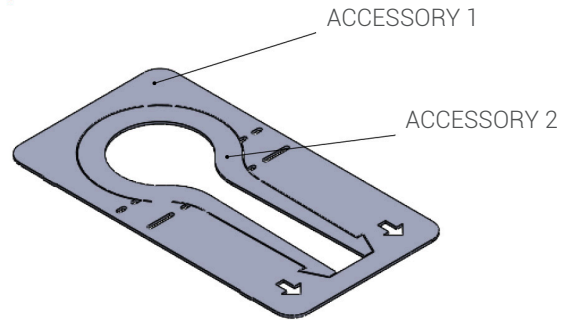

PLATE FOR AIR JET REMOVAL



STEP 1 - REMOVING THE INDICATED PART SWINGING IT UNTIL IT IS COMPLETELY REMOVED



STEP 2 - PRESS ON THE INDICATED PART UNTIL THE TWO ACCESSORIES ARE SEPARATED

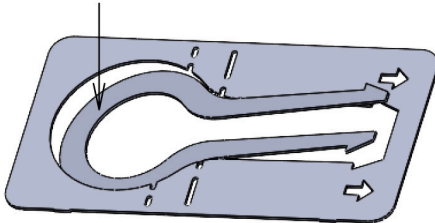

ACCESSORY 1
- FOR UNLOCKING THE FLAPS ON THE PLATE

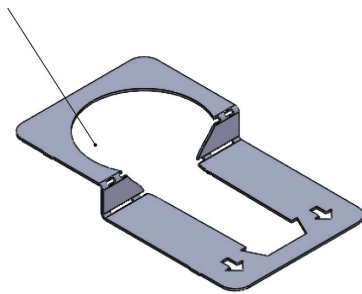

ACCESSORY 2
- FOR THE REMOVAL OF THE GRILLES / AIR JET ON THE WALL

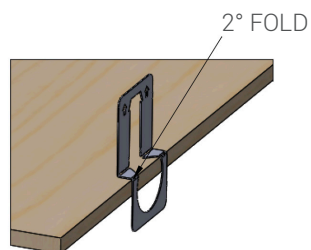
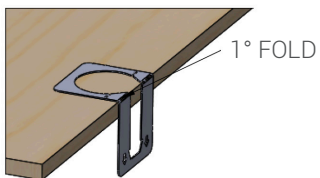
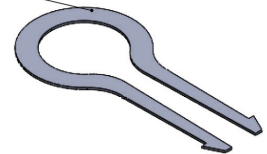

REMOVAL GRILL

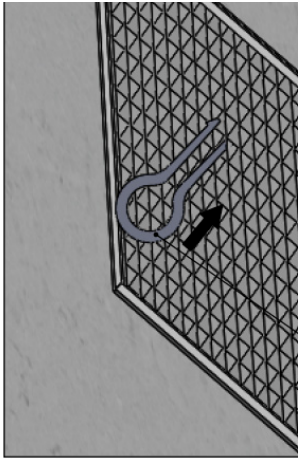

STEP 1- PUT ACCESSORY 2 INSIDE THE CRATE GRILLE UNTIL THE HOOK ARE LOCKED

ACCESSORY 2

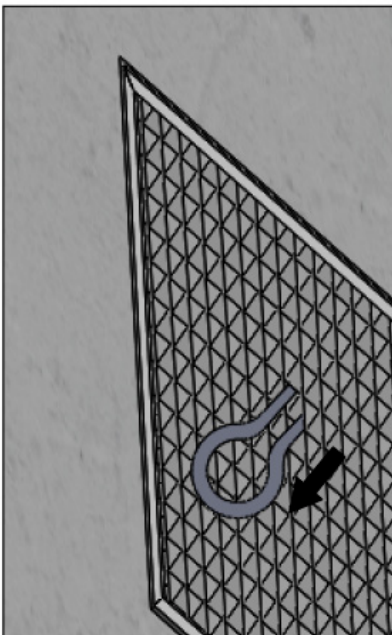

STEP 2- GENTLY PULL THE ACCESSORY, AS SHOWN IN THE FIGURE, BY HOLDING IT IN TRACTION UNTIL THE STEPS ARE COMPLETE

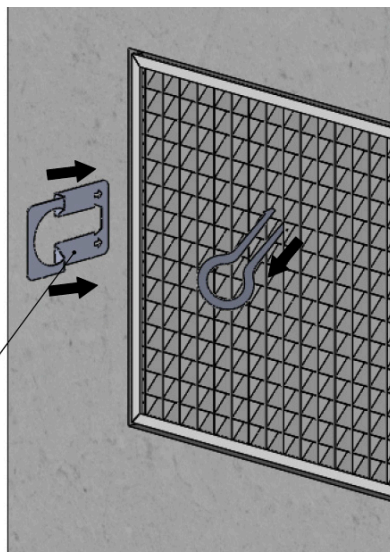

STEP 3- INSERT ACCESSORY 1 Laterally BETWEEN GRILLE AND WALL, UNTIL THE FOLDED PART IS FLAT

ACCESSORY 1

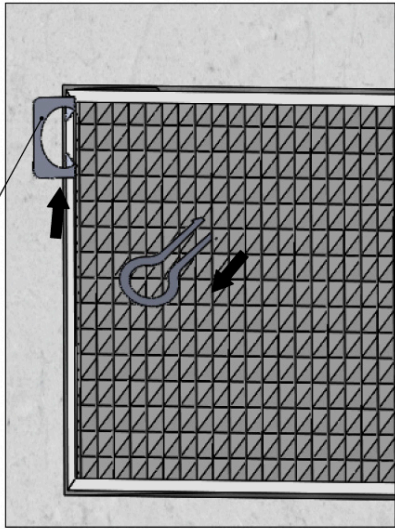

STEP 4- SLIDE ACCESSORY 1 UPWARD UNTIL THE TOP OF THE GRILLE IS RELEASED

ACCESSORY 1

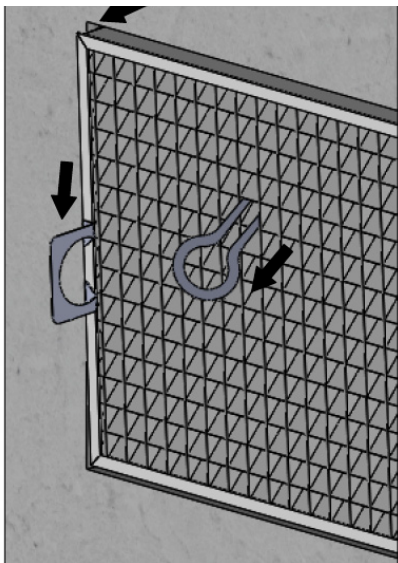

STEP 5- SLIDE THE ACCESSORY DOWNWARD UNTIL THE GRILLE IS COMPLETELY DISENGAGED

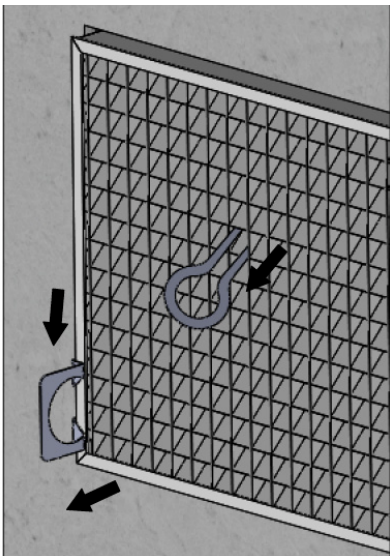

STEP 6- REMOVE THE GRILLE FROM THE MOUNTING PLATE

