

# FILTER CEILING

## Series EFPLA - EFPLAS



Our filter ceilings are designed for installation in high-risk environments and offer a practical and safe filter fixing system. Thanks to the integrated diffusion networks, which generate a homogeneous and directed air flow over the entire surface, an anti-induction barrier is created in compliance with the NFS 90-351 regulation.

Each filter ceiling is composed of a false ceiling structure, specifically designed for hospital operating rooms. The frame is available in stainless steel or in a painted version, and is structured to house high-efficiency filters (H14) and is supplied with diffusion networks that guarantee a unidirectional air flow above the work areas. For customized projects, with sizes and compatibles other than the standards, we invite you to contact our offices.

Main features: 9 sizes available.  
Air flow rate between 2.350 m<sup>3</sup>/h and 12.400 m<sup>3</sup>/h.  
Standard height of 450 mm.  
High efficiency H14 filters with standard thickness of 68 mm.

### PLENUM:

- RAL 9010 painted steel sheet.
- Pressure connection (Ø7 mm) on the surgical light.
- 25 mm angle in the lower part for installation of the false ceiling.
- Angular iron equipped with fixing holes (Ø10 mm every 50 cm) in the upper part for fixing to the slab.
- Side air intake through a rigid attachment (height 200 mm - depth 150 mm).

### HIGH EFFICIENCY FILTERS

- Filter sizes (mm): 305x610x68 - 610x610x68 - 915x610x68 - 1220x610x68
  - Efficiency: H14.
- (EXCLUDED FROM THE SUPPLY, TO BE PURCHASED SEPARATELY).

### FILTER SUPPORT FRAMES

- RAL 9010 painted steel sheet.
- Self-supporting frame in the lower part on which the filters are mounted.
- Junction plane perfectly sealed, without possibility of leaking from corners.
- Assembly of frame/frame and frame/plenum at the factory.
- 4 or 6 fixing filters stainless steel block 1/4 turn.
- 4 inserts fixing grids or covers.

### SURGICAL LAMP PASSAGE - VERSION EFPLAS

- RAL 9010 painted steel sheet.
- In the center of the frame is a dedicated airtight section.
- Pressure socket with crystal tube that allows the integrity test or the measurement of the filter obstruction from the room.
- Easy access to the base of the operating light thanks to 2 waterproof and removable half plates.

### SECURE FLOW DIFFUSION GRIDS

- Steel sheet (perforation rate: 40%) painted white RAL 9010.
- Unidirectional air diffusion, without flow interruptions compliant with NFS 90-351.

### MODELS

EFPLA: not prepared for surgical lamp  
EFPLAS: prepared for surgical lamp

## EFPLAS Technical specifications (prepared for surgical lamp)

Model	Global dimensions [mm]	Attack dimensions [mm]	Ø surgical lamp [mm]	Max Ø for surgical lamp - ON REQUEST (mm)	Total weight [kg]	Filters		air flow rate of supply [m³/h] as a function of the exit speed from the filters		
						n°	Dimensions (mm)	0,25 [m/s]	0,28 [m/s]	0,32 [m/s]
EFPLAS-1	2060x1330x450	1000x200x150	190	490	98	2	1220x610x68	1670	1870	2138
						2	305x610x68			
EFPLAS-2	2730x1330x450	1000x200x150	190	490	120	3	1220x610x68	2350	2650	3000
						2	305x610x68			
EFPLAS-3	2060x2000x450	1550x200x150	190	560	134	4	915x610x68	2660	3000	3400
						2	610x610x68			
EFPLAS-4	2610x2060x450	1550x200x150	190	560	160	4	1220x610x68	3700	4100	4700
						2	915x610x68			
EFPLAS-5	2730x2670x450	2100x200x150	190	620	210	10	915x610x68	5000	5600	6400
EFPLAS-6	2975x2060x450	1800x200x150	190	620	184	7	915x610x68	4200	4700	5350
						1	1220x610x68			
EFPLAS-7	3280x2730x450	2350x200x150	190	620	244	8	1220x610x68	6350	7100	8100
						2	915x610x68			
EFPLAS-8	3400x3280x450	2950x200x150	190	620	296	12	1220x610x68	8000	9000	10300
EFPLAS-9	4070x3280x450	3580x200x150	190	620	352	14	1220x610x68	9700	10850	12400
						2	305x610x68			

## EFPLA Technical Specifications (not prepared for surgical lamp)

Model	Global dimensions [mm]	Attack dimensions [mm]	Total weight [kg]	Filters		air flow rate of supply [m³/h] as a function of the exit speed from the filters		
				n°	Dimensions (mm)	0,25 [m/s]	0,28 [m/s]	0,32 [m/s]
EFPLA-1	1390x1330x450	900x200x150	63	2	1220x610x68	1333	1493	1707
EFPLA-2	2060x1025x450	1300x200x150	75	3	915x610x68	1500	1680	1920
EFPLA-3	2060x1330x450	1550x200x150	88	3	1220x610x68	2000	2240	2560
EFPLA-4	2060x2000x450	1550x200x150	126	6	915x610x68	3000	3360	3840
EFPLA-5	2610x1390x450	2100x200x150	111	4	1220x610x68	2667	2987	3413
EFPLA-6	2610x2060x450	2100x200x150	156	6	1220x610x68	4000	4480	5120
EFPLA-7	2730x2610x450	2350x200x150	196	8	1220x610x68	5238	5866	6703
EFPLA-8	2975x1390x450	2100x200x150	133	6	915x610x68	3000	3360	3840
EFPLA-9	2975x2060x450	2350x200x150	181	9	915x610x68	4500	5040	5800

## Filter operating data

	thickness 68 mm
initial pressure drop	120 Pa
recommended final pressure drop	300 Pa
final pressure drop max	600 Pa
max temperature	80° C
max umidity	100%
filtration efficiency class (EN 1822-1)	H 14

Pa : pressure drop in Pascal

## Filter size and air flow

model	surface filters
A x B x C	m²
305x610x68	5,2
610x610x68	10,5
610x915x68	15,8
610x1220x68	21,4

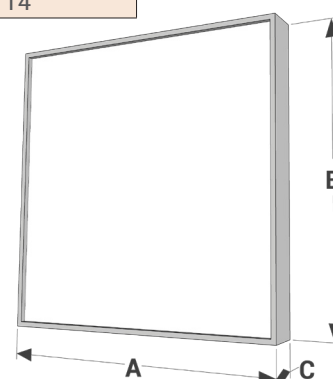

## EFPLAS 1 DIMENSIONS

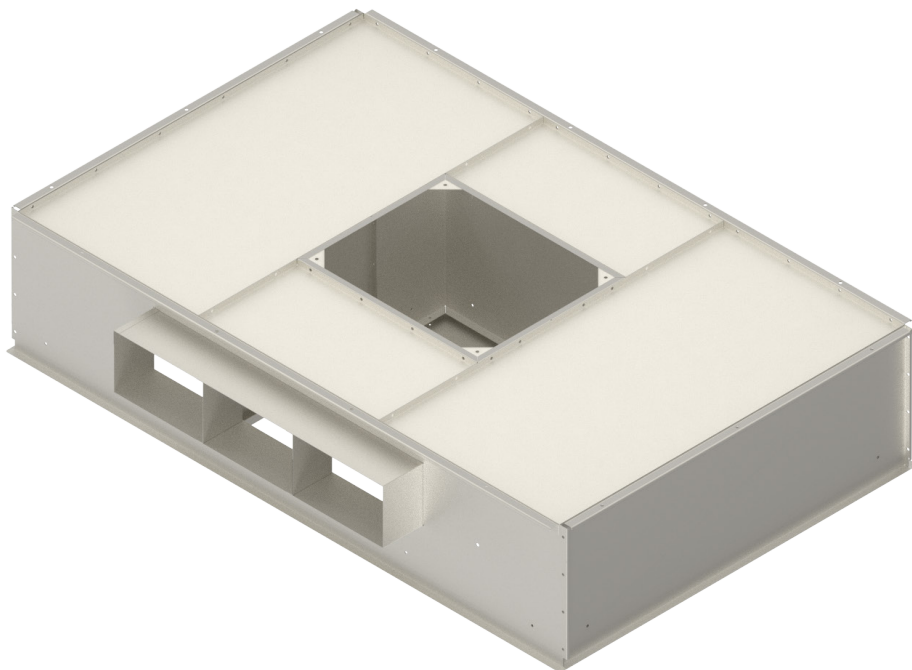
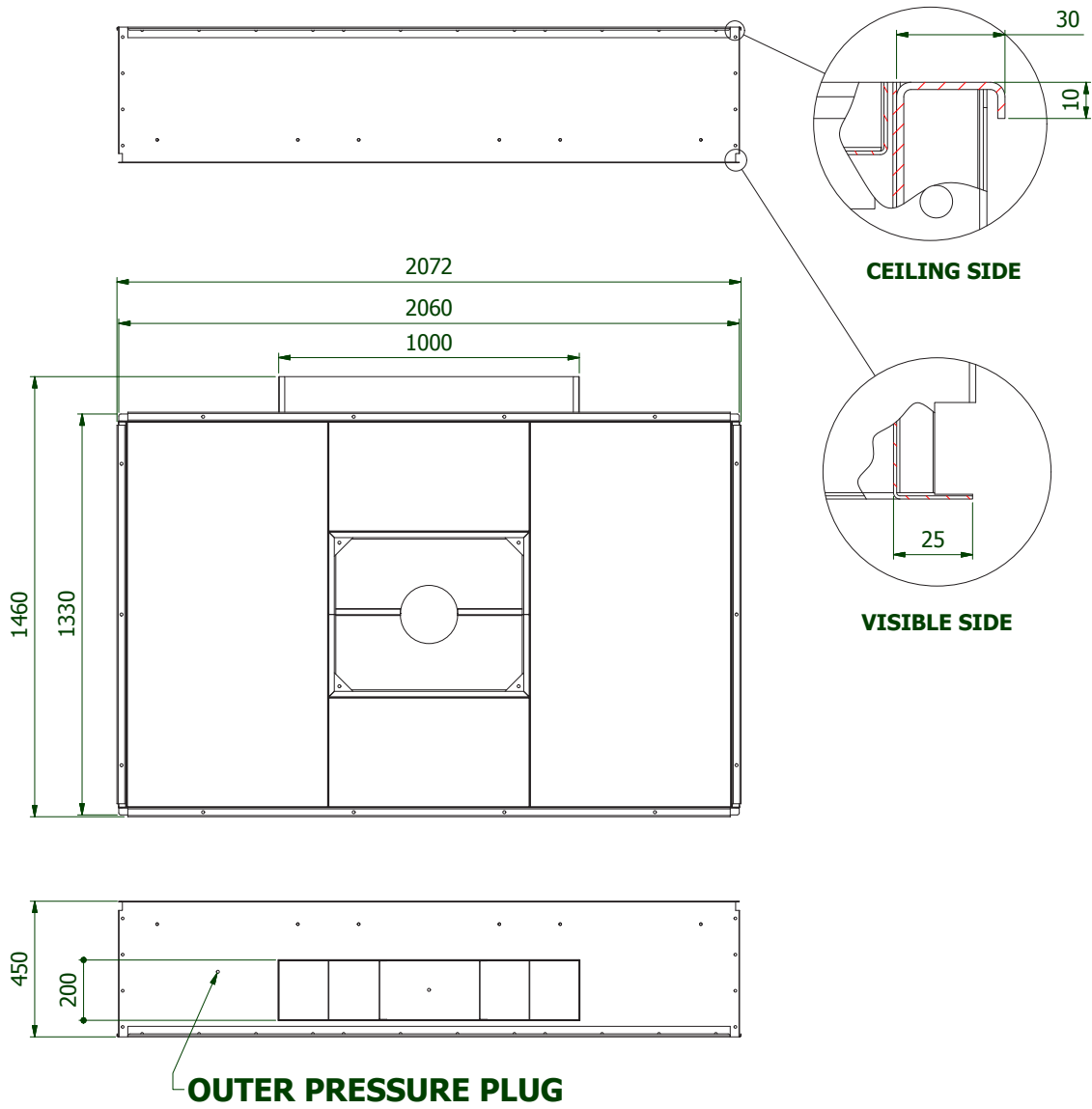

## EFPLAS 2 DIMENSIONS

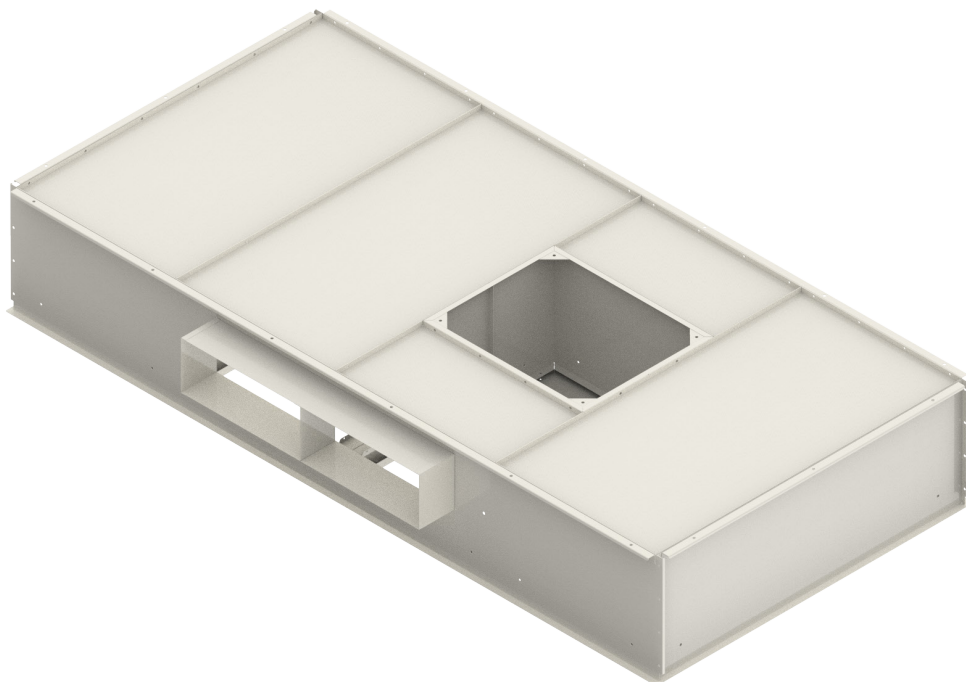
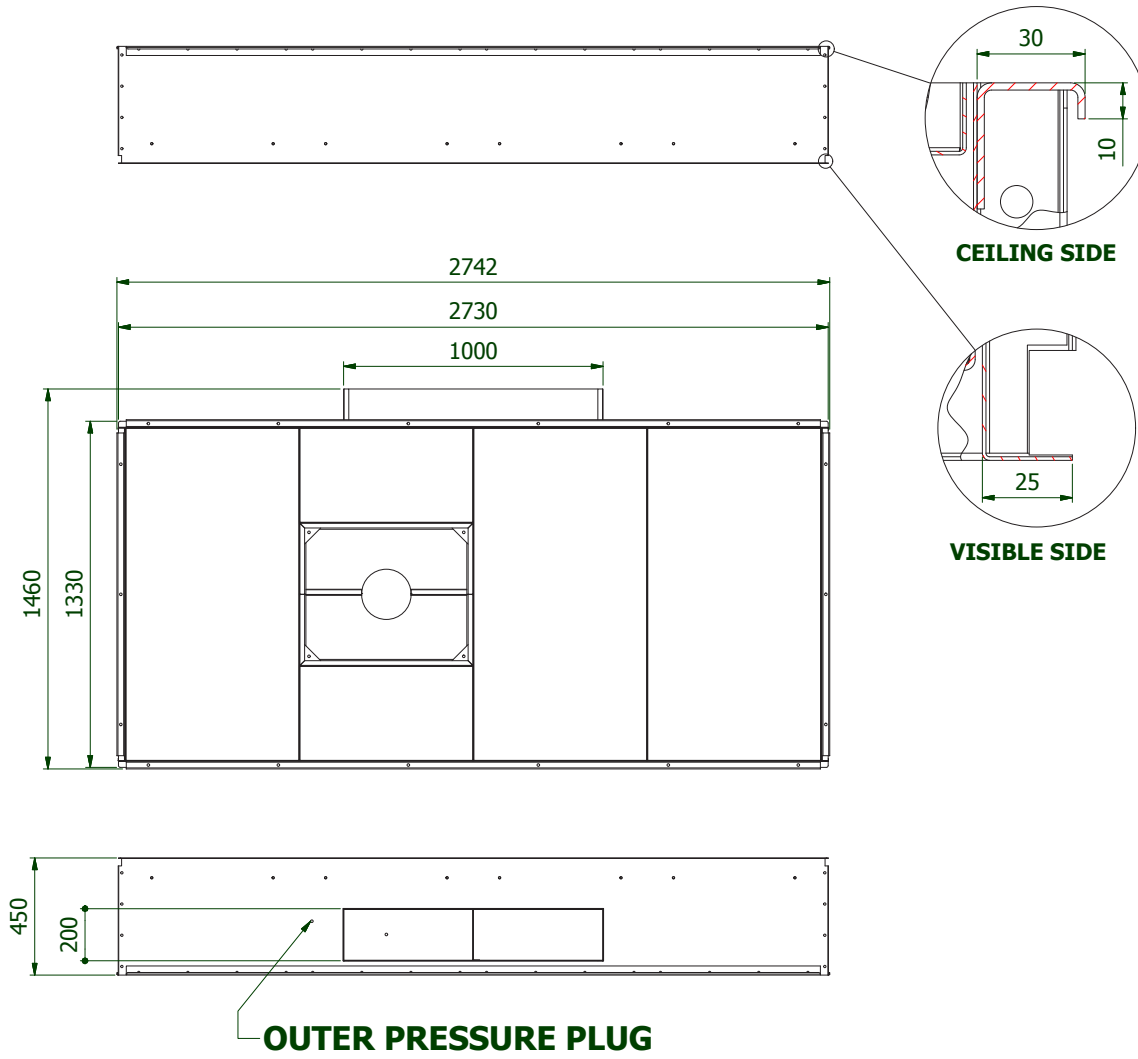

## EFPLAS 3 DIMENSIONS

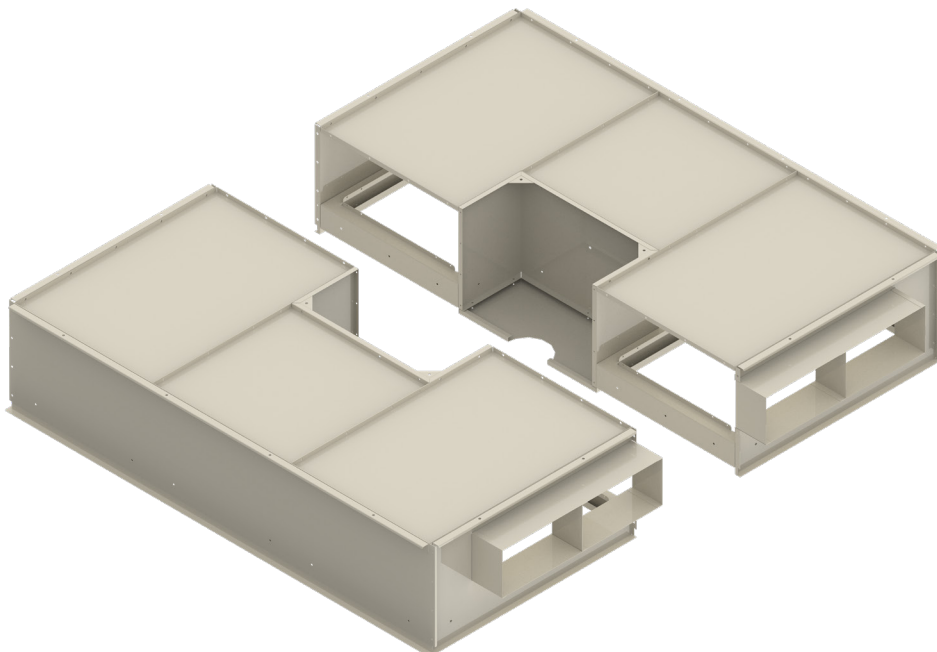
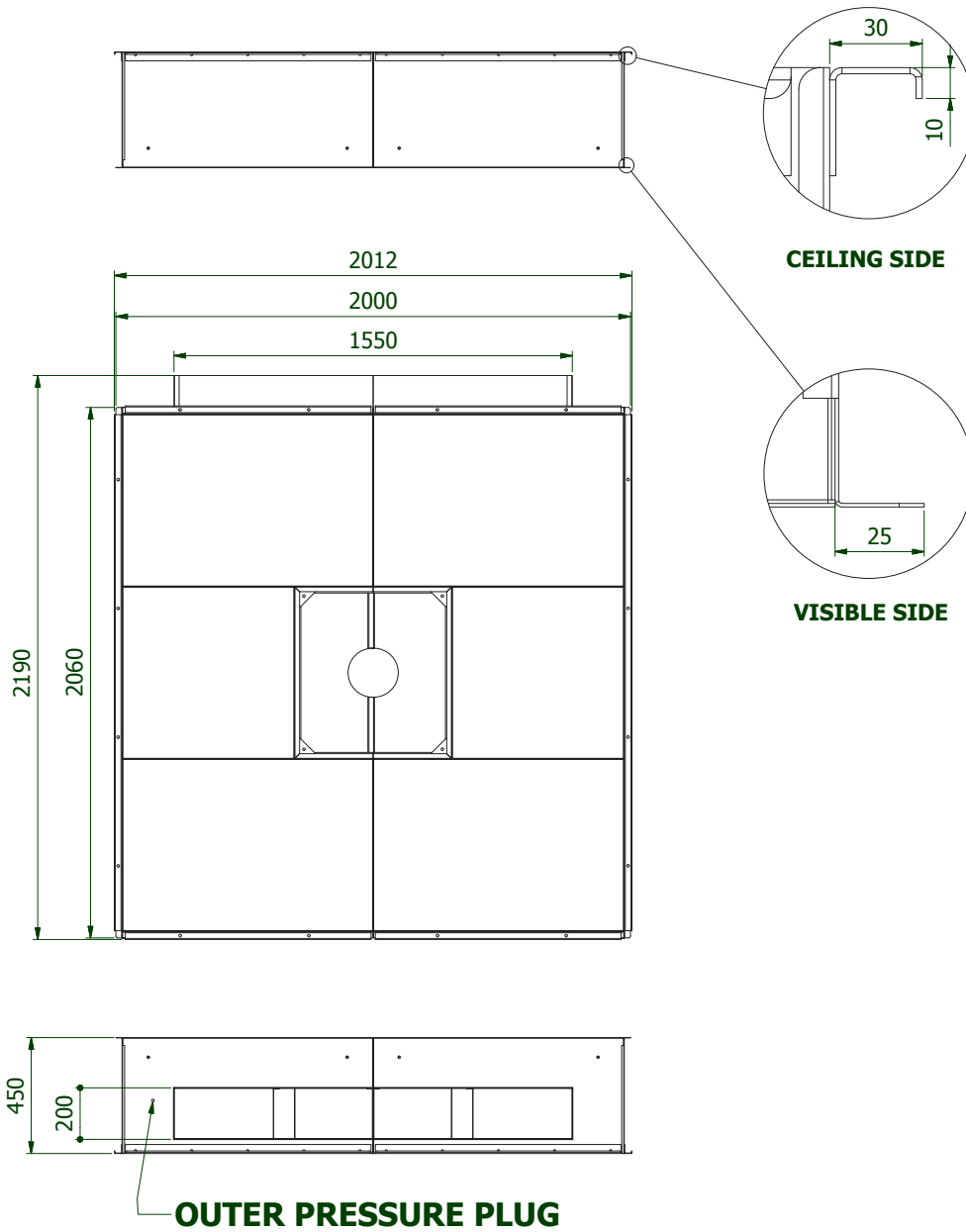

## EFPLAS 4 DIMENSIONS

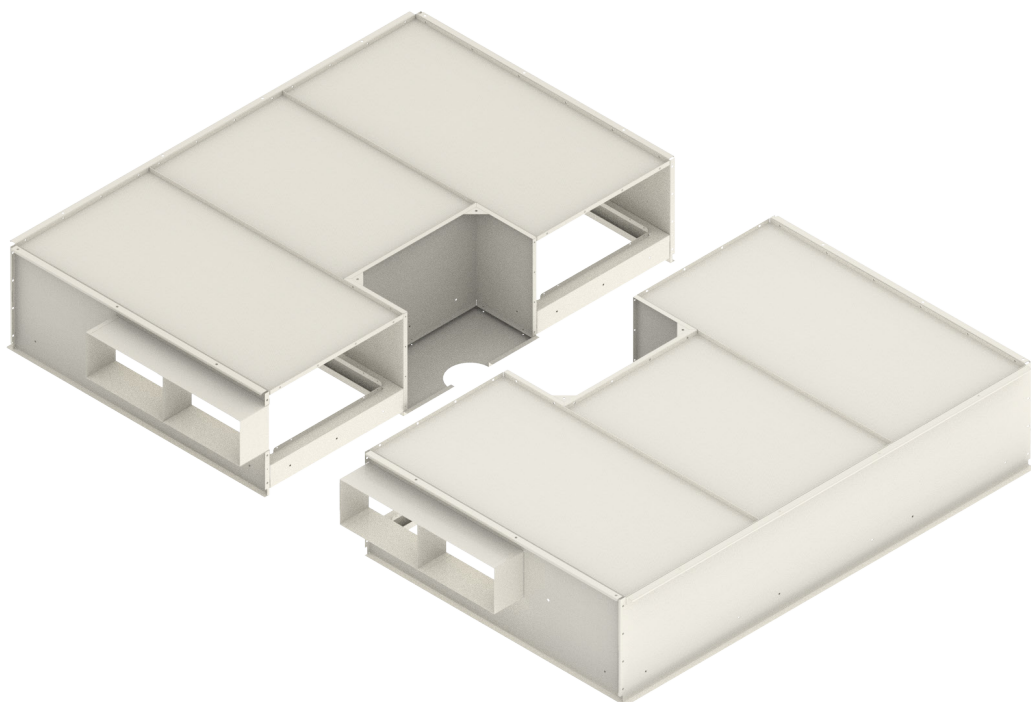
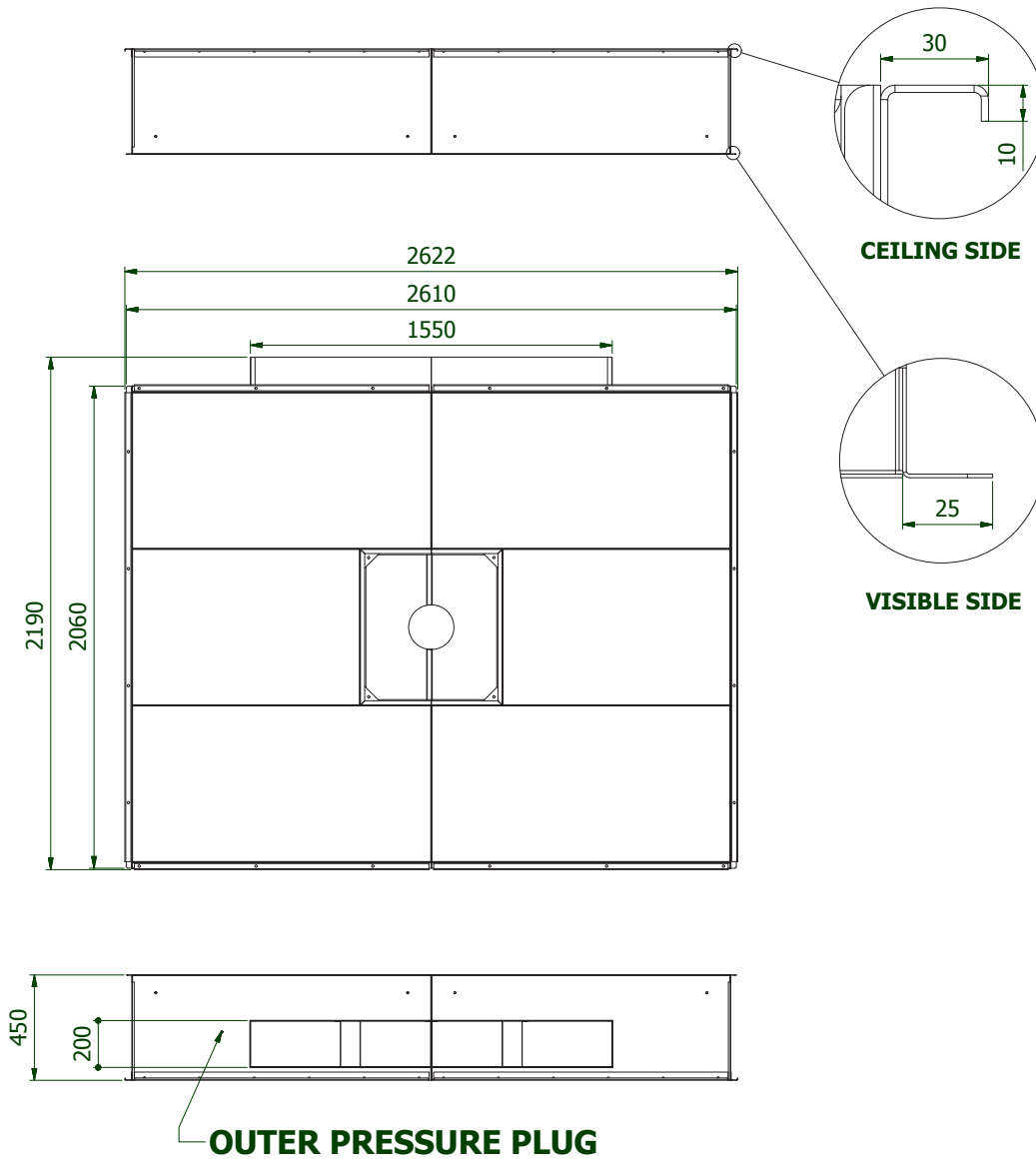

## EFPLAS 5 DIMENSIONS

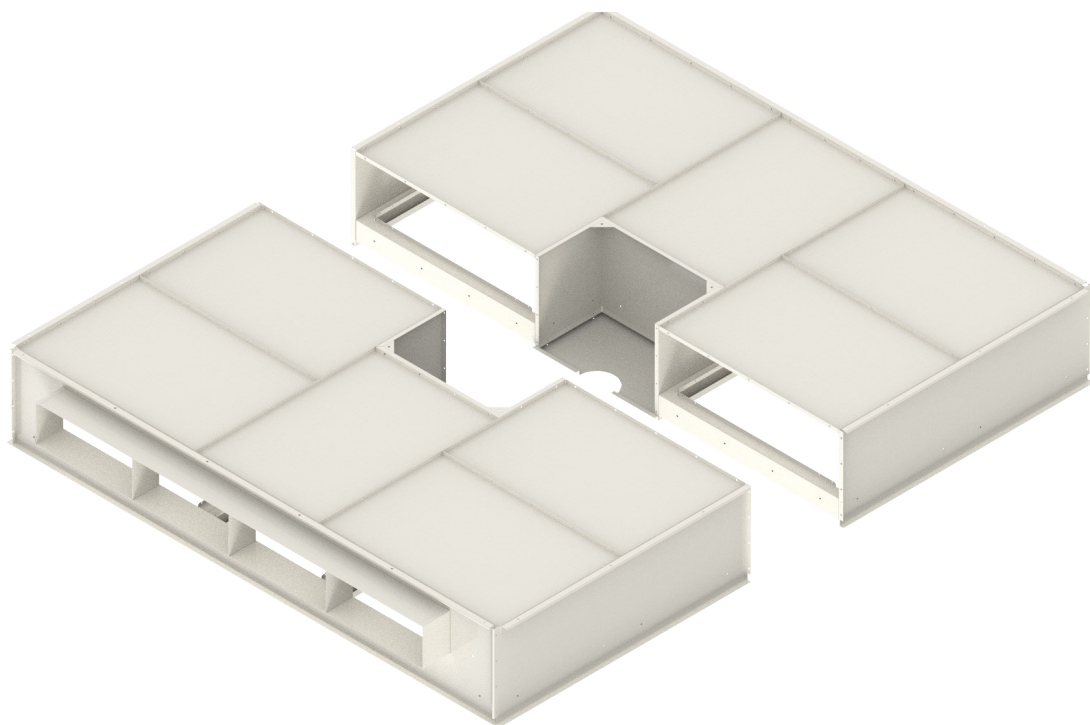
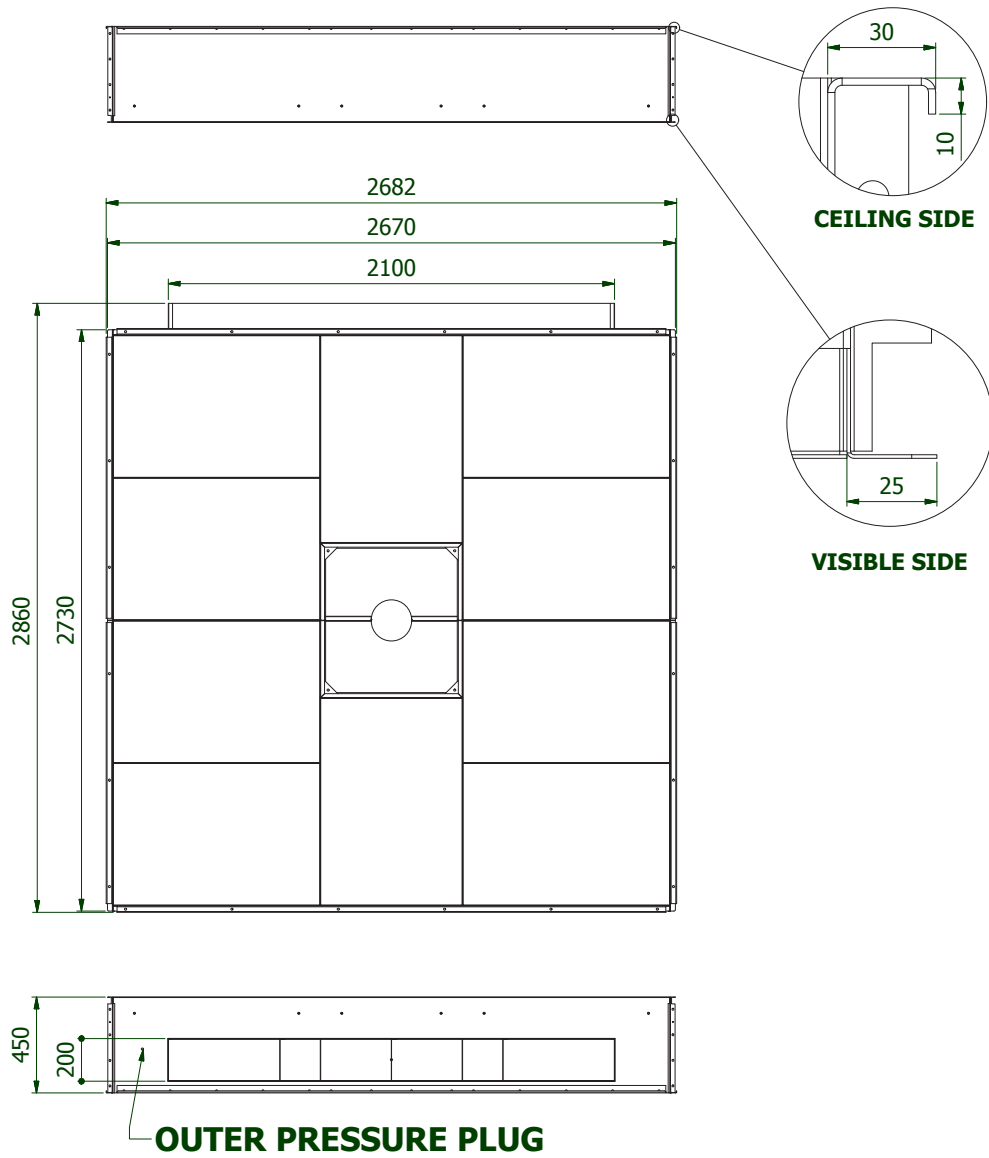

## EFPLAS 6 DIMENSIONS

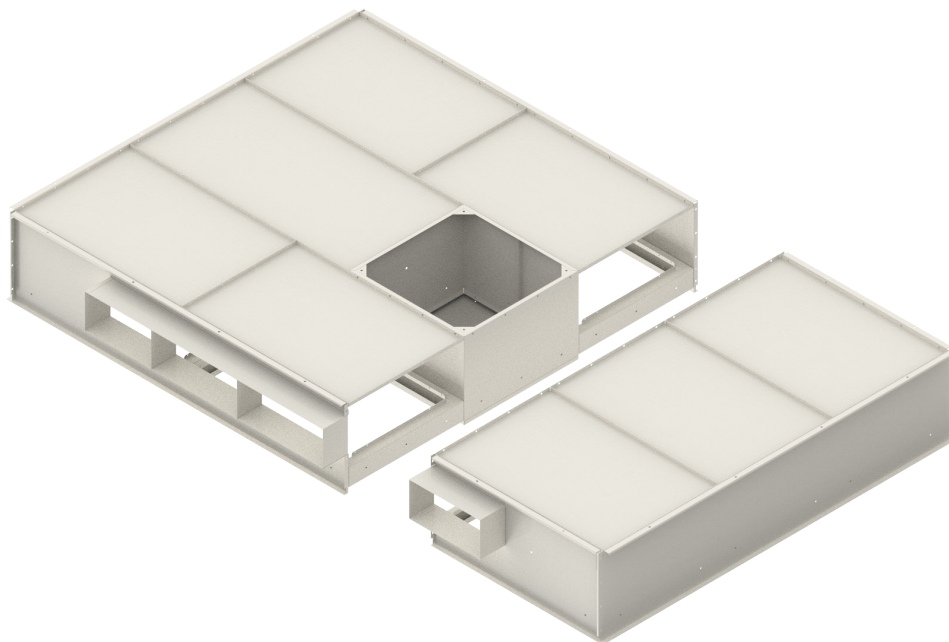
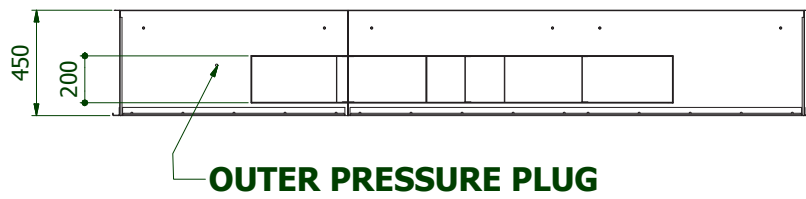
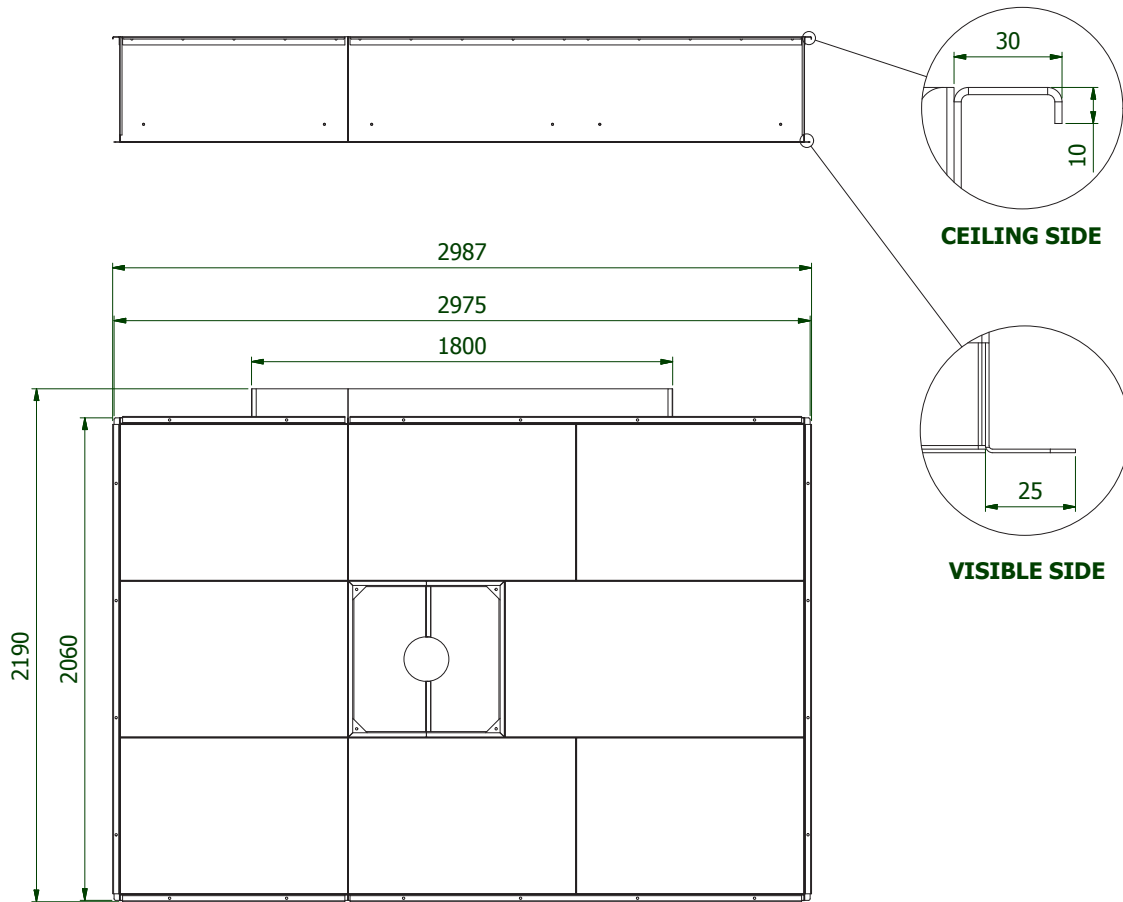



## EFPLAS 7 DIMENSIONS

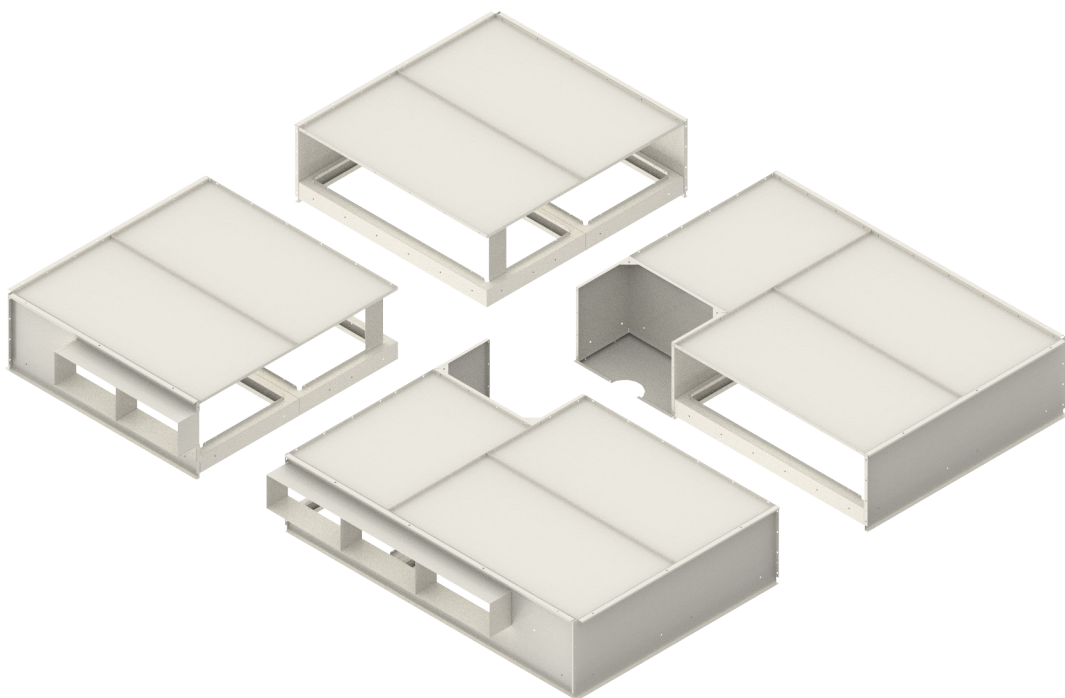
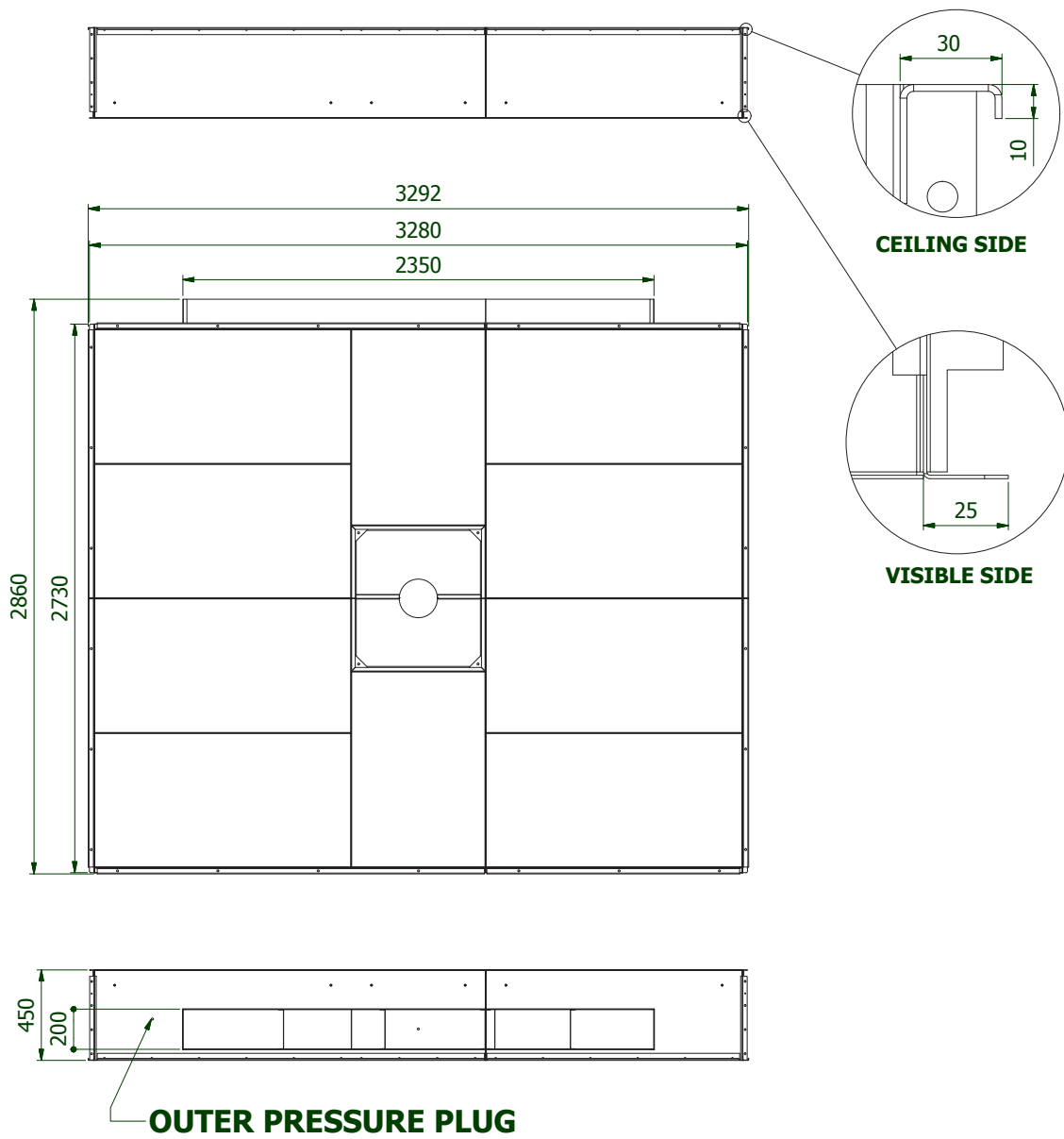

## EFPLAS 8 DIMENSIONS

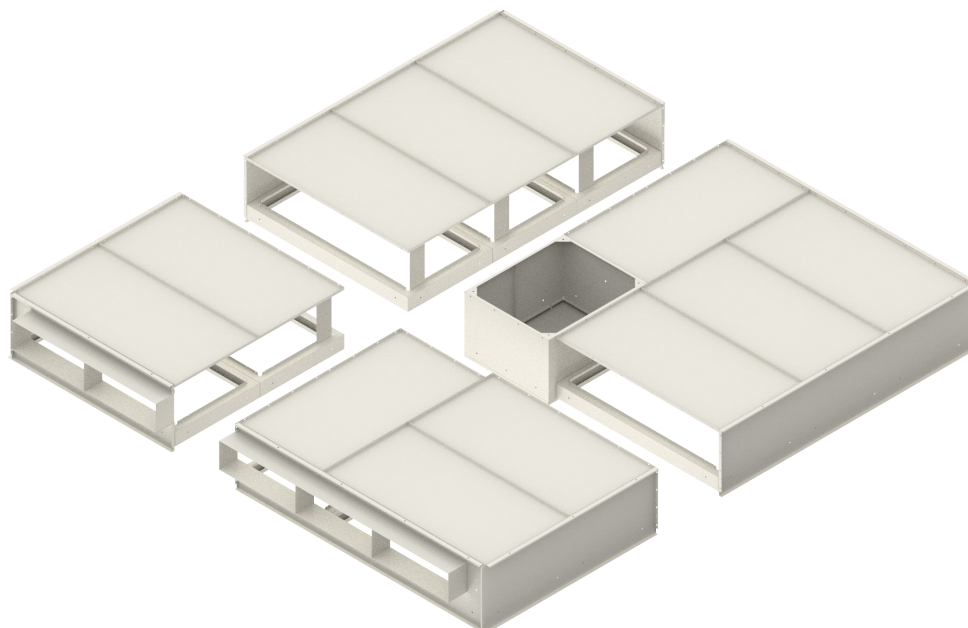
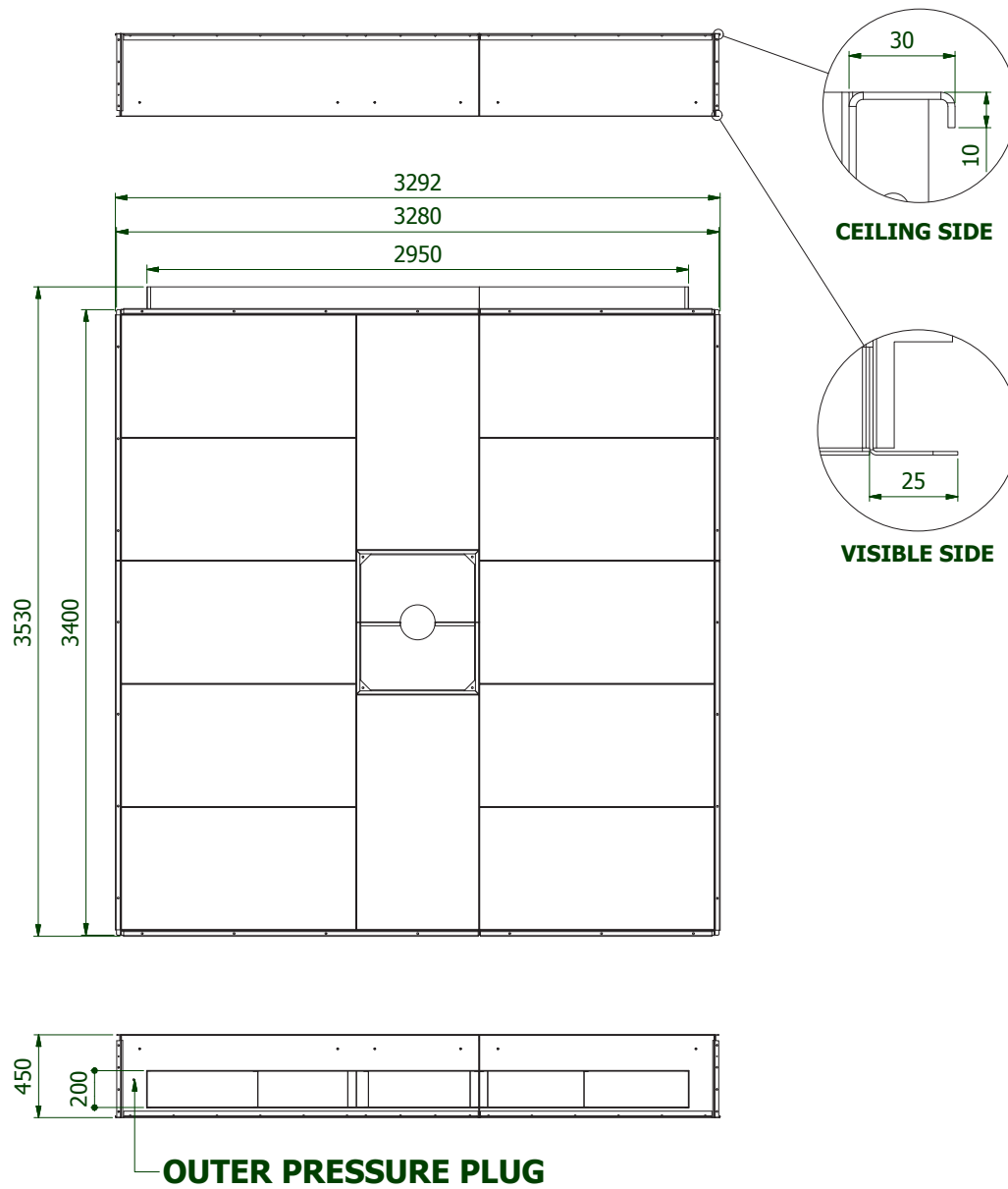

## EFPLAS 9 DIMENSIONS

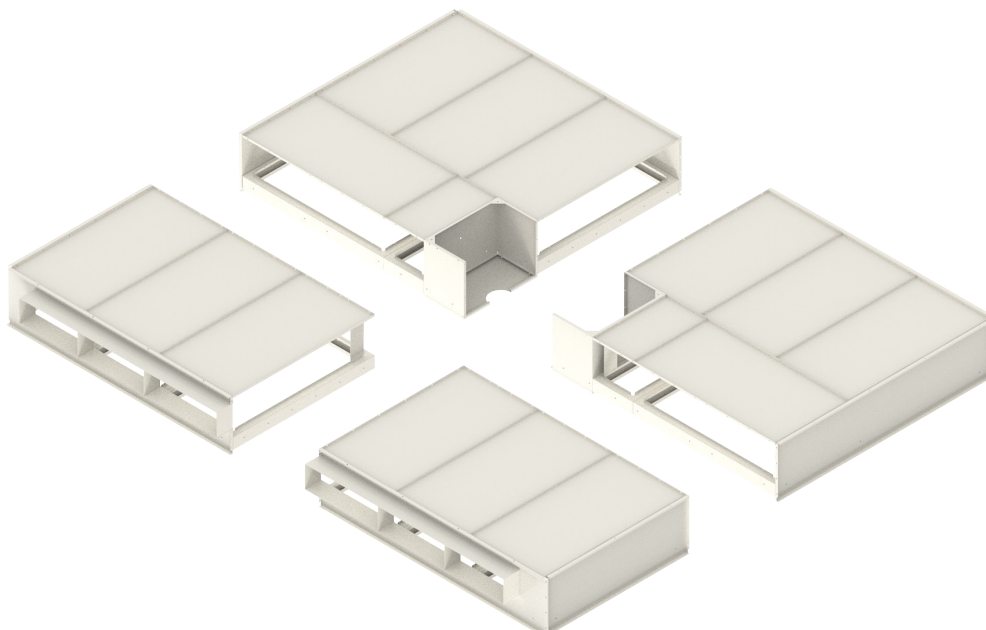
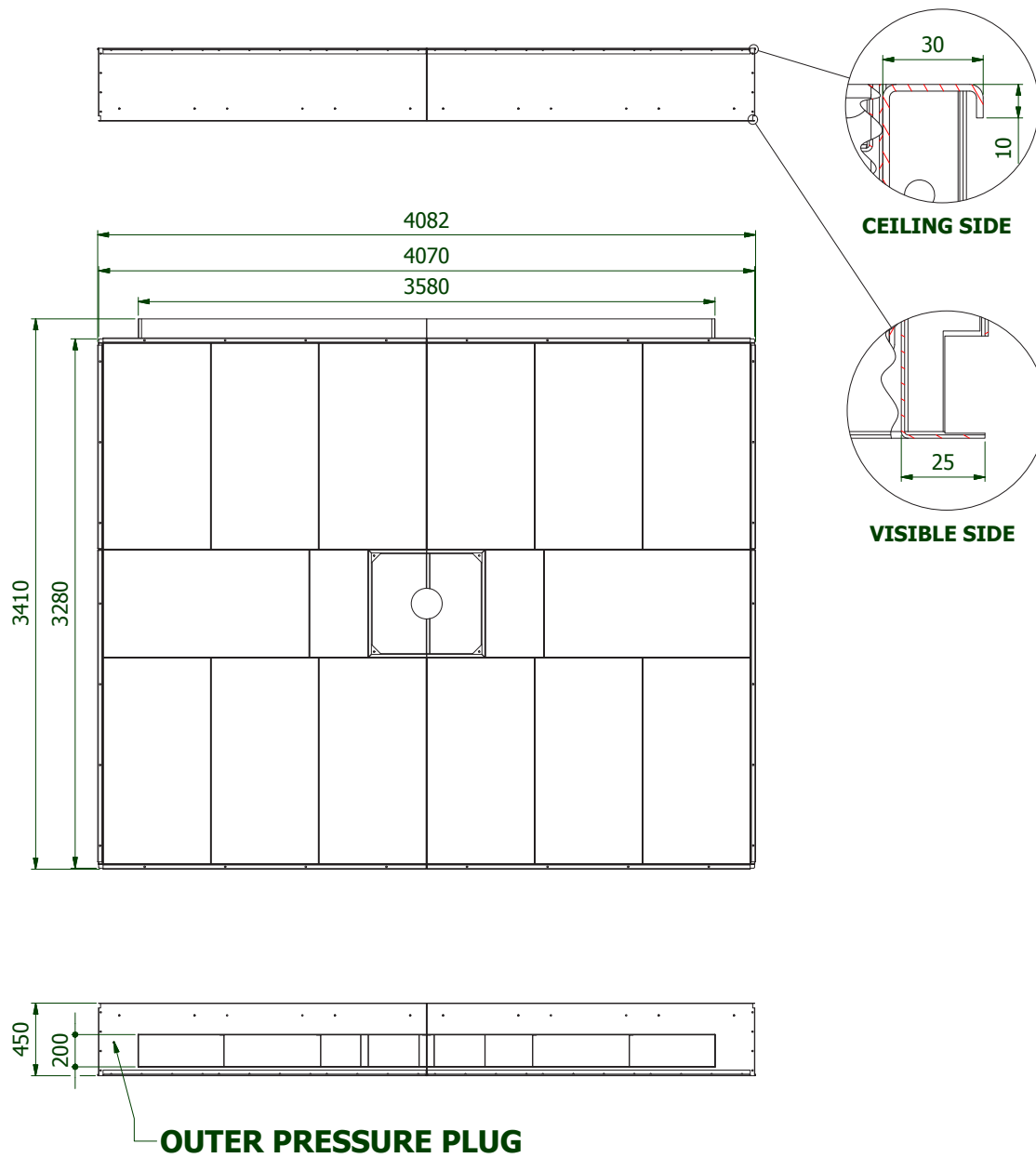

## EFPLA 1 DIMENSIONS

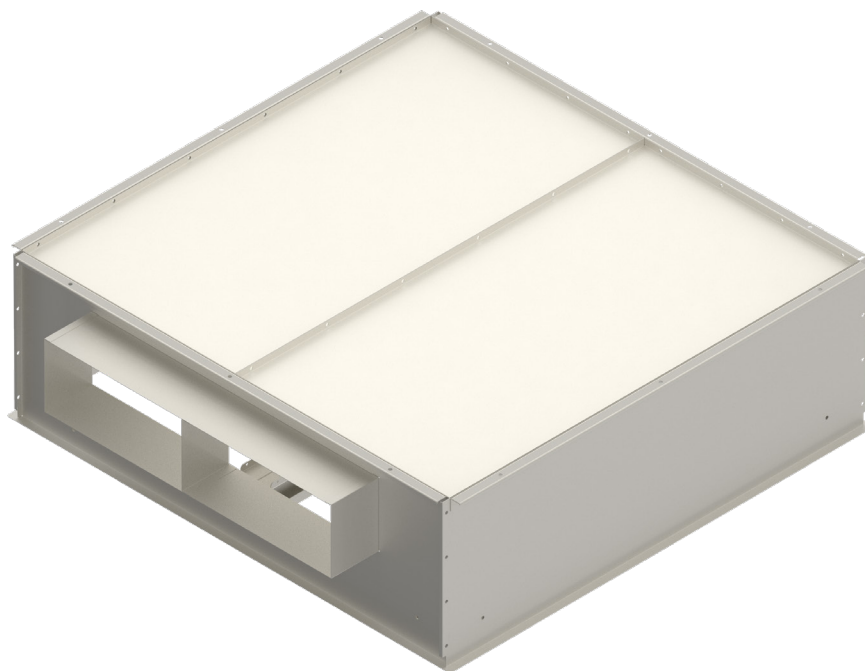
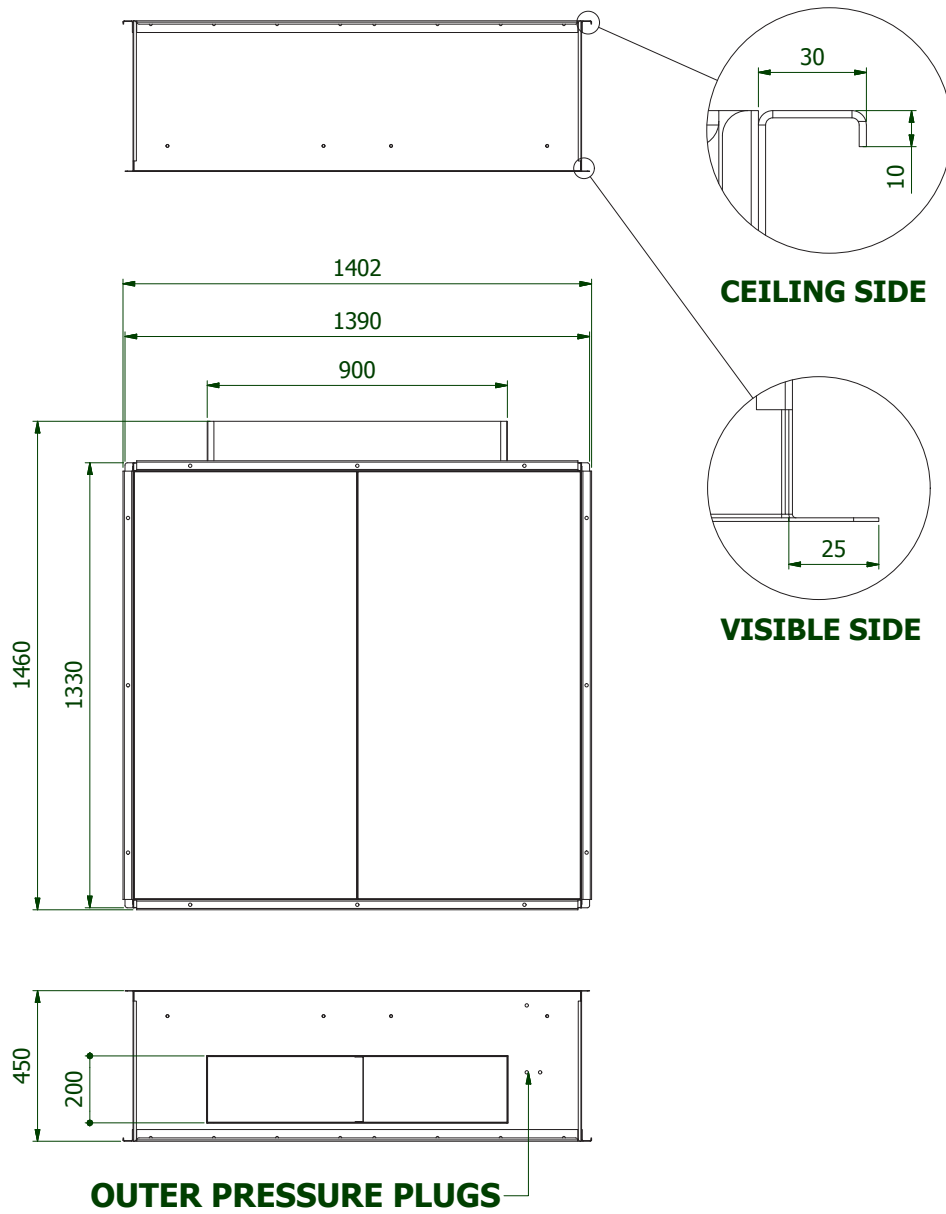

## EFPLA 2 DIMENSIONS

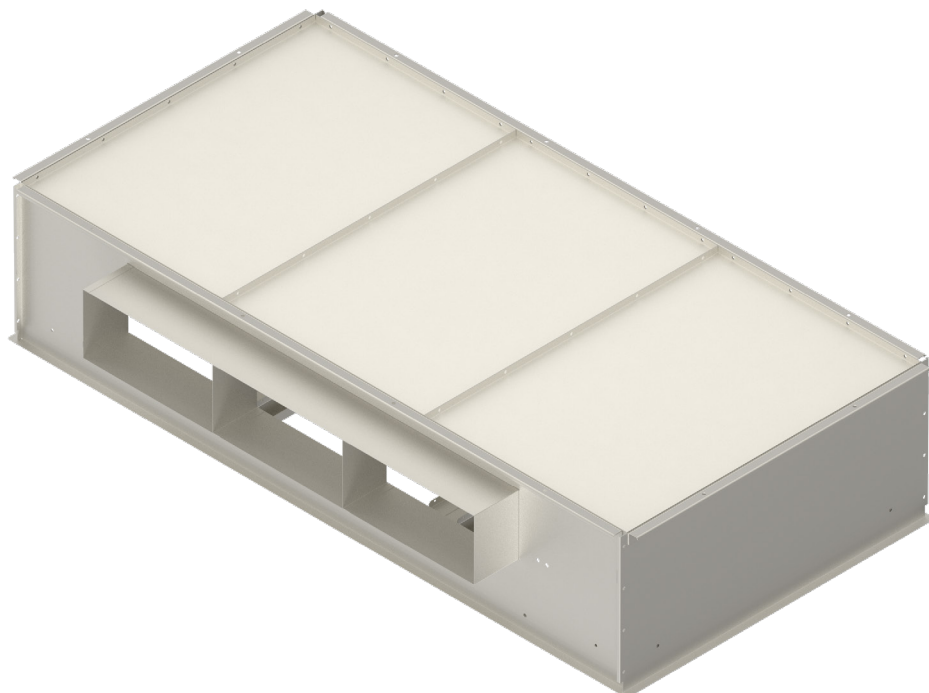
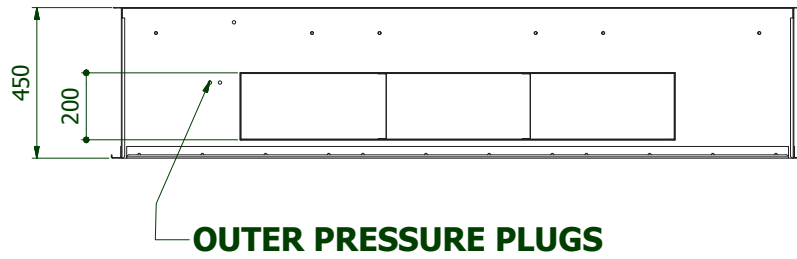
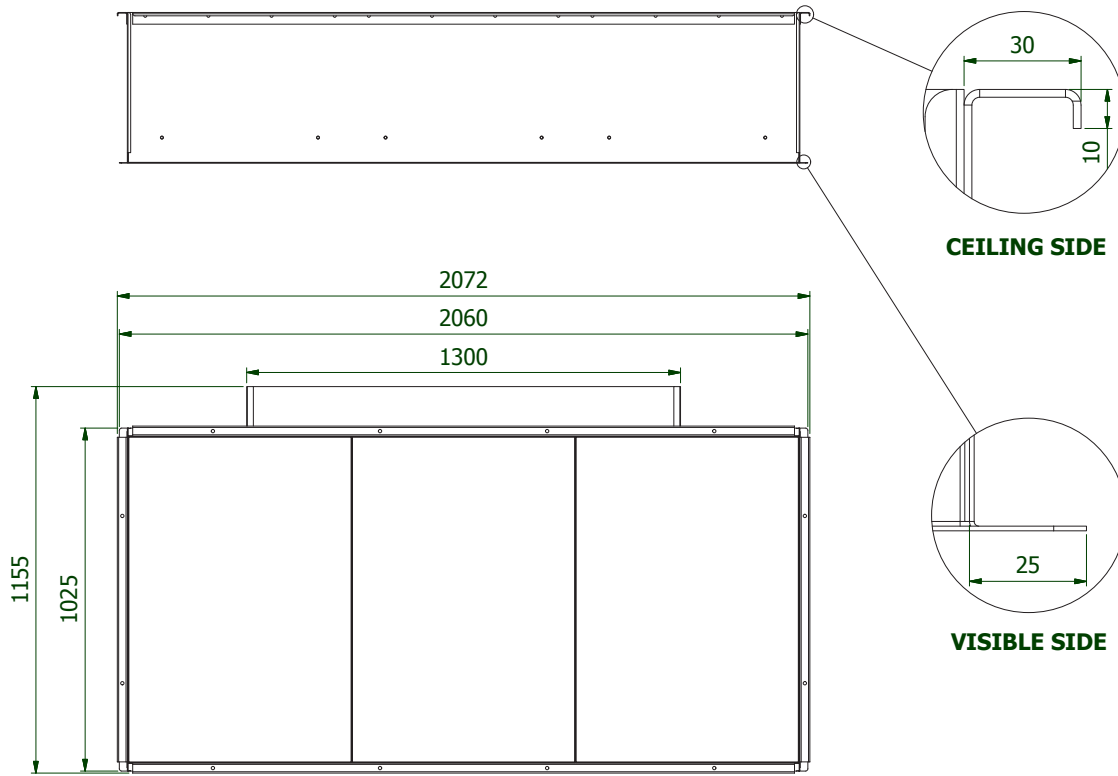

## EFPLA 3 DIMENSIONS

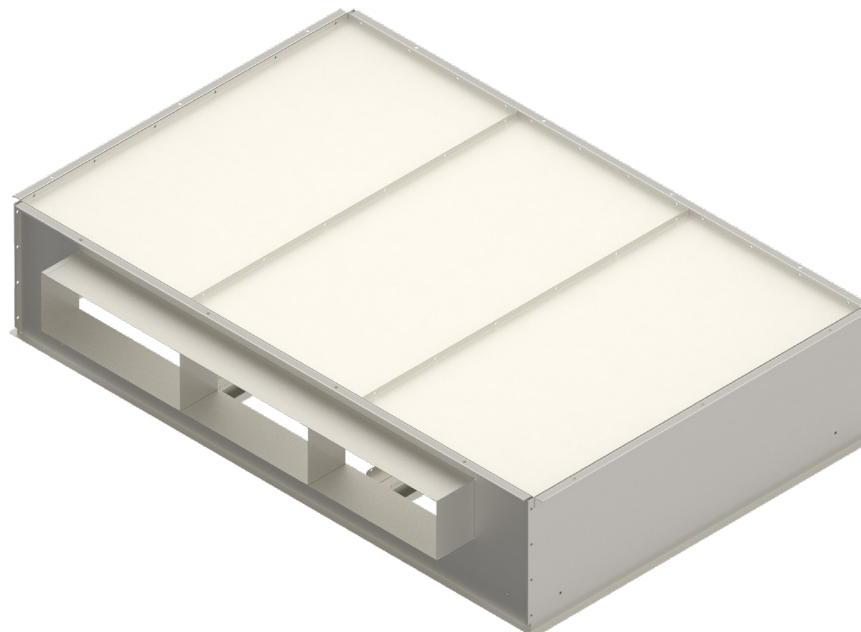
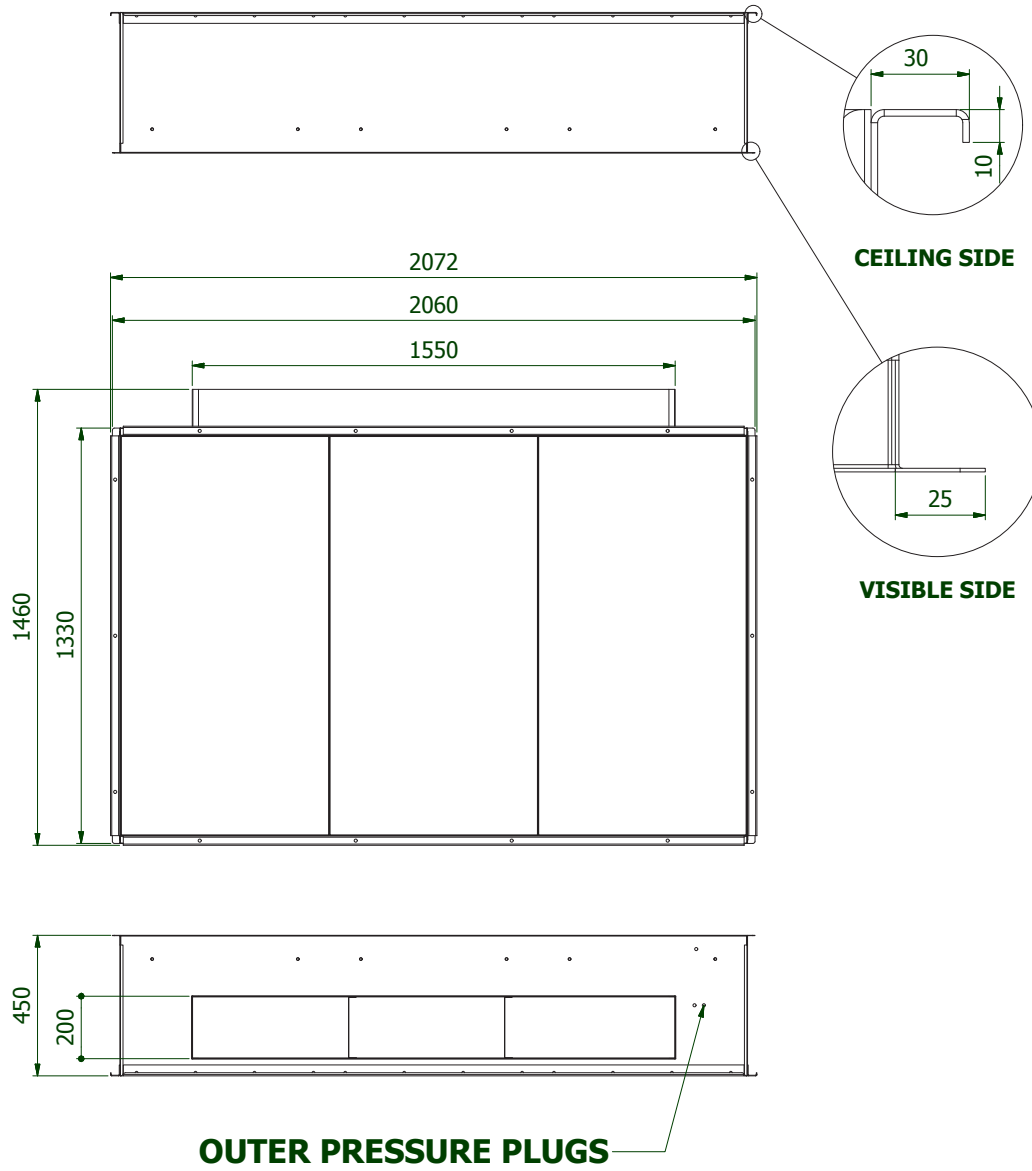

## EFPLA 4 DIMENSIONS

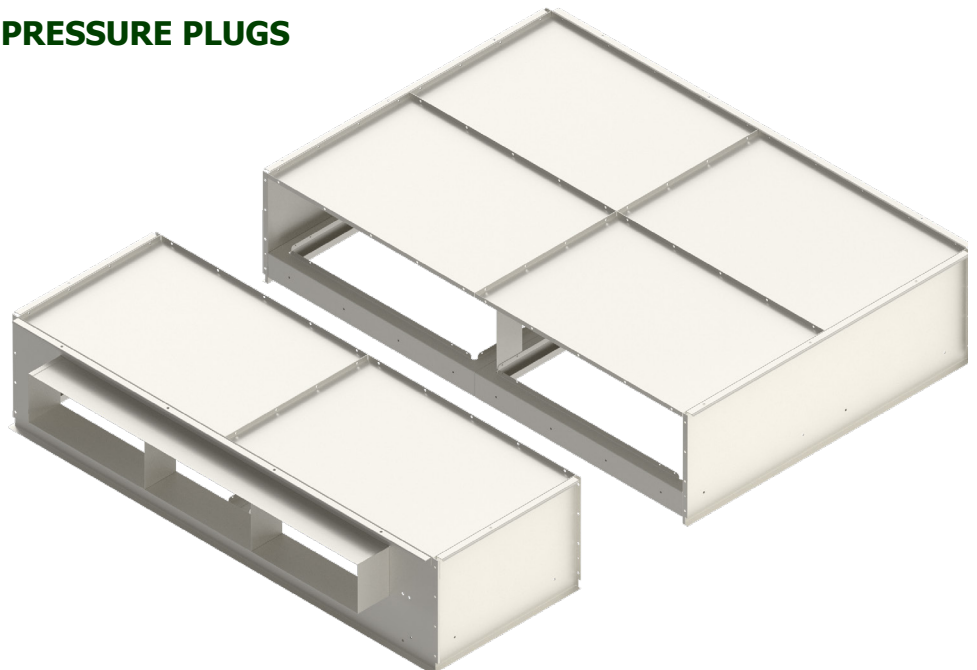
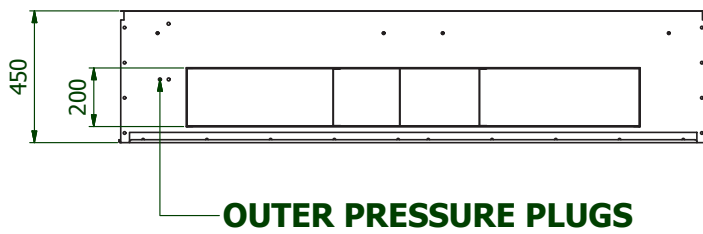
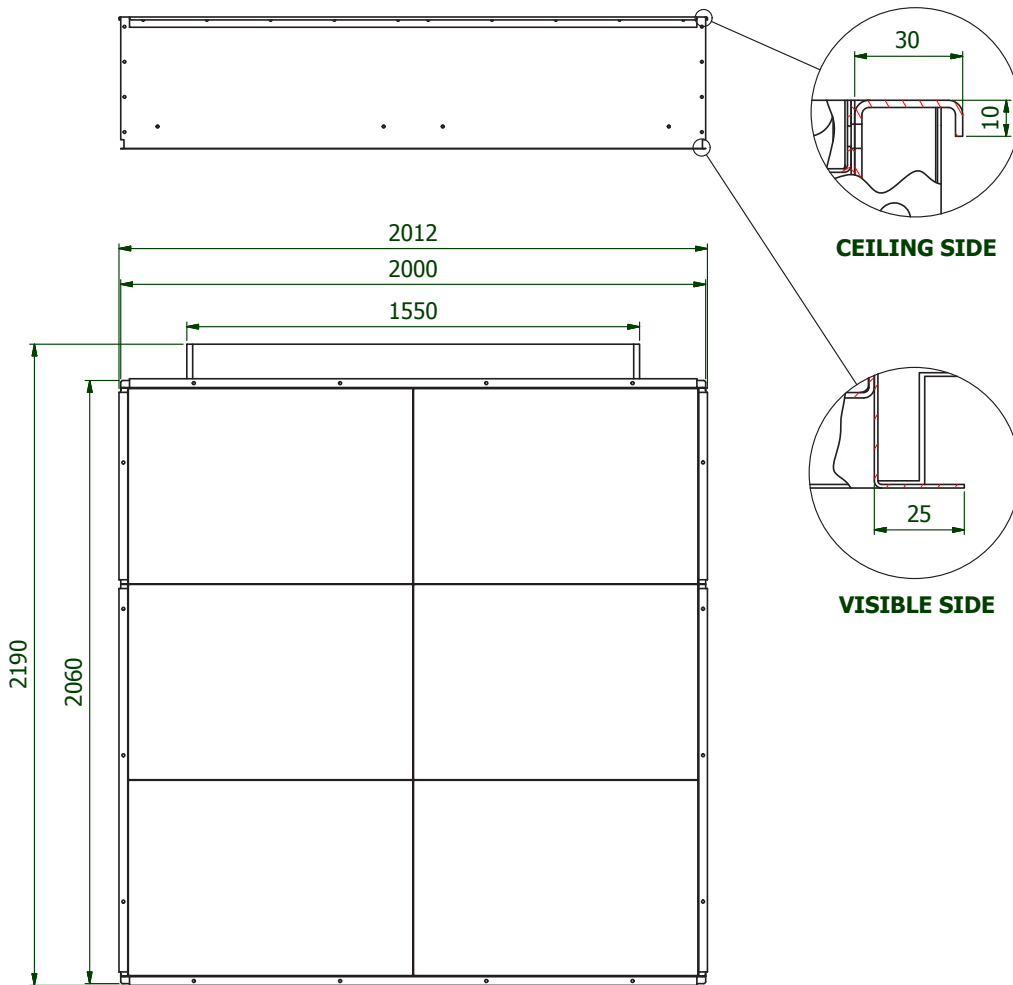

## EFPLA 5 DIMENSIONS

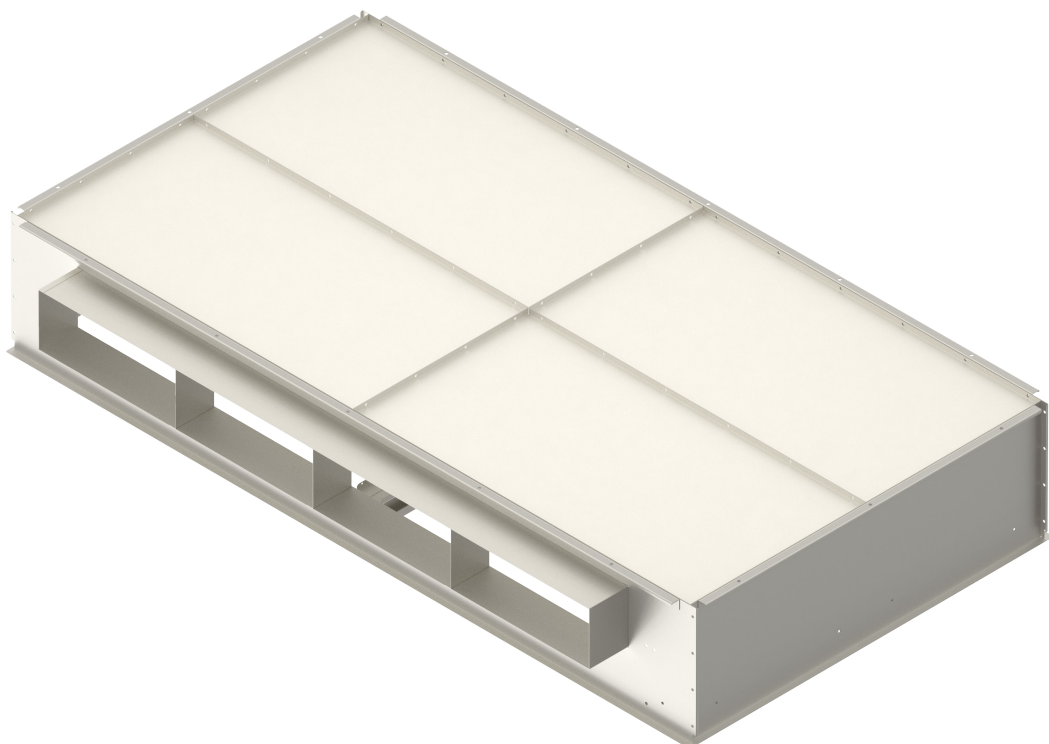
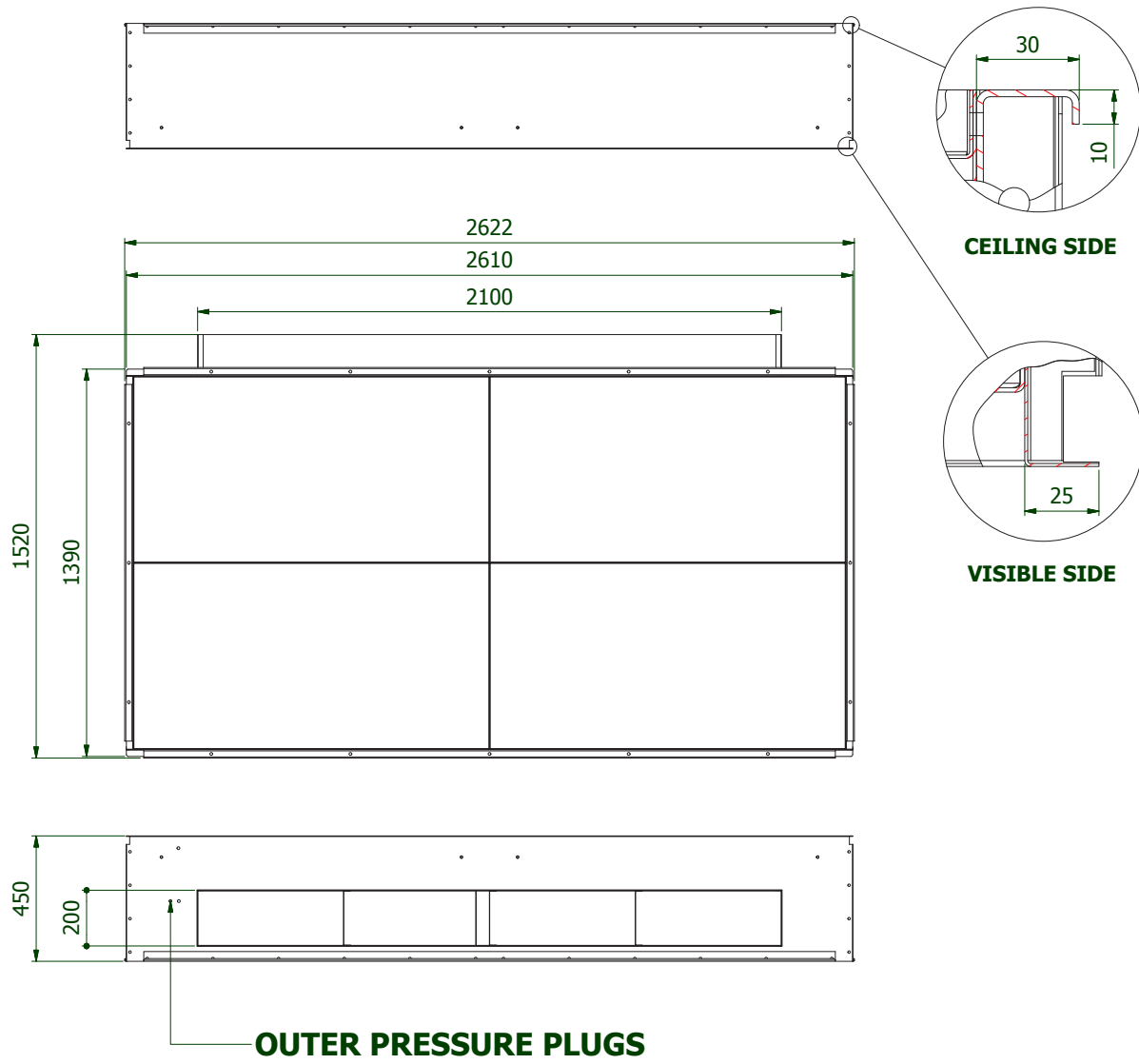



## EFPLA 6 DIMENSIONS

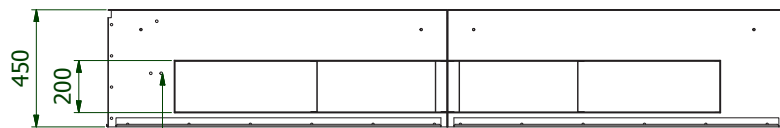
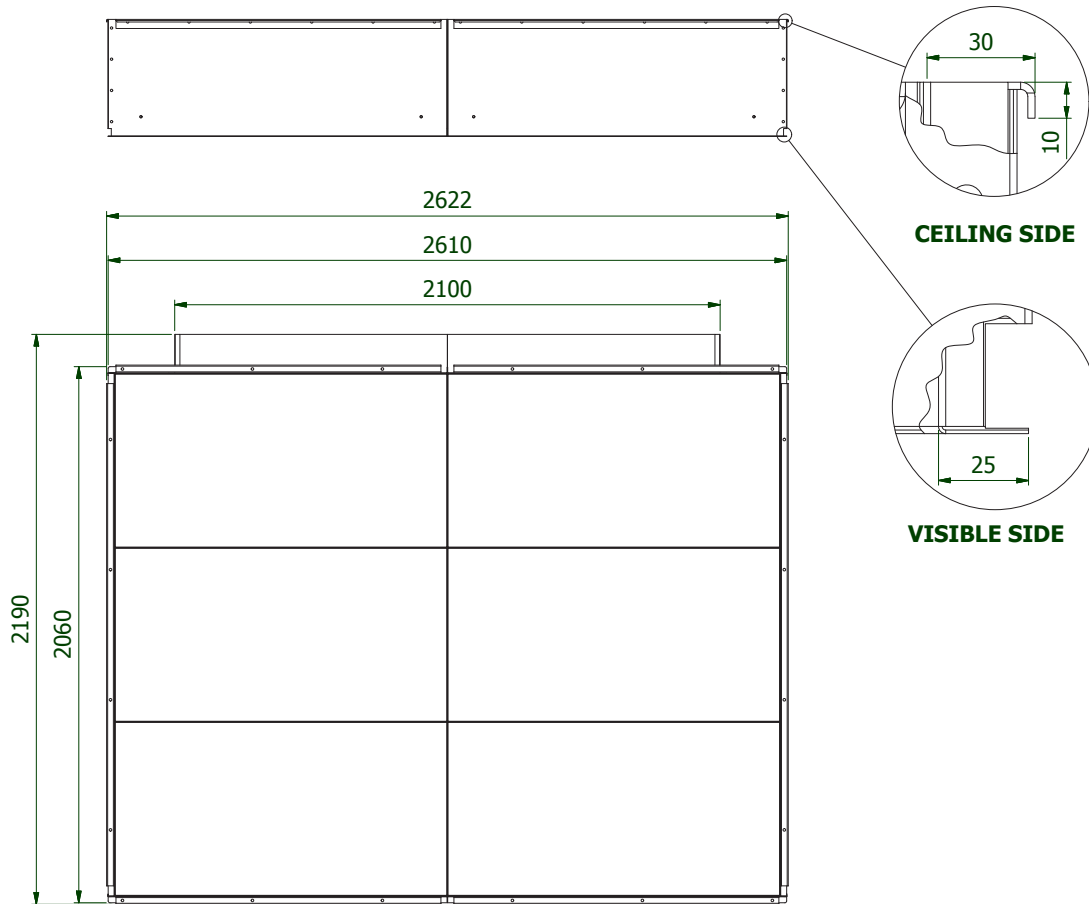

### OUTER PRESSURE PLUGS

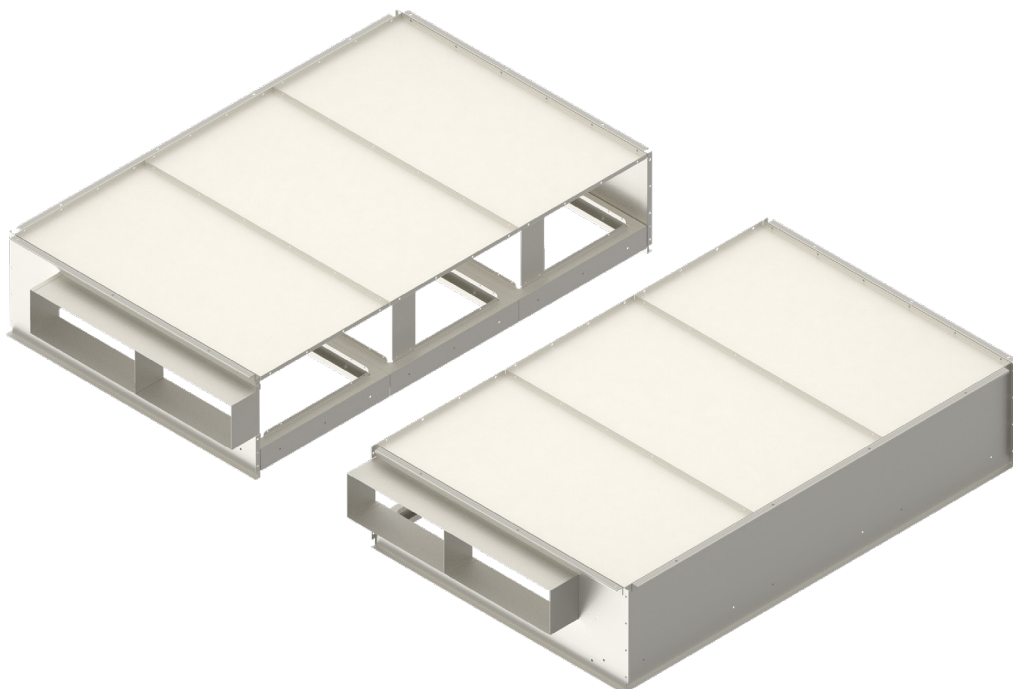

## EFPLA 7 DIMENSIONS

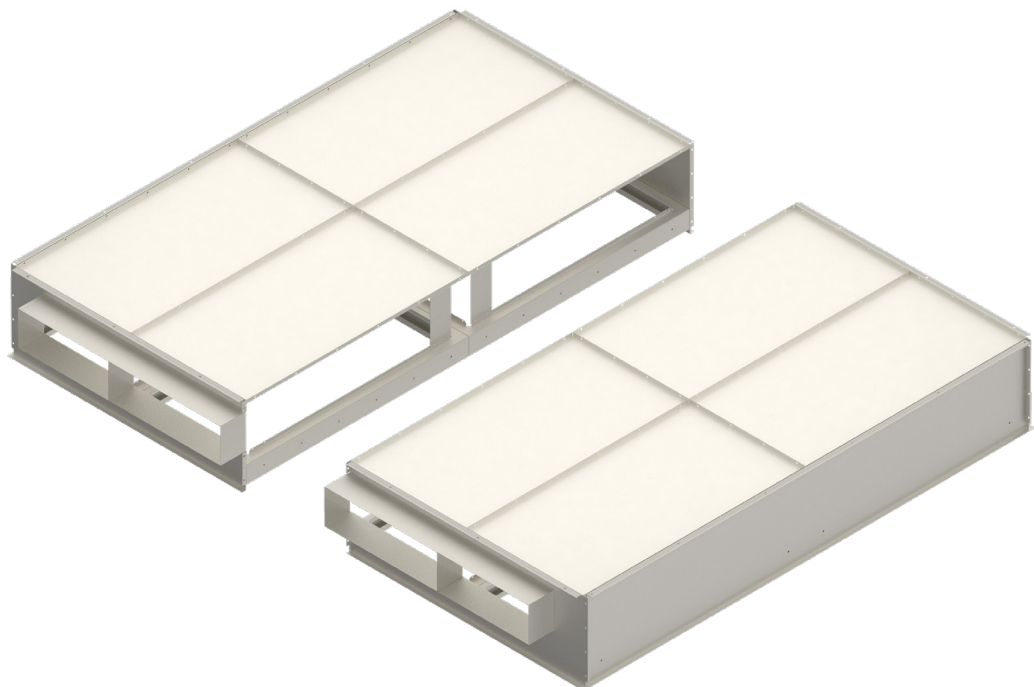
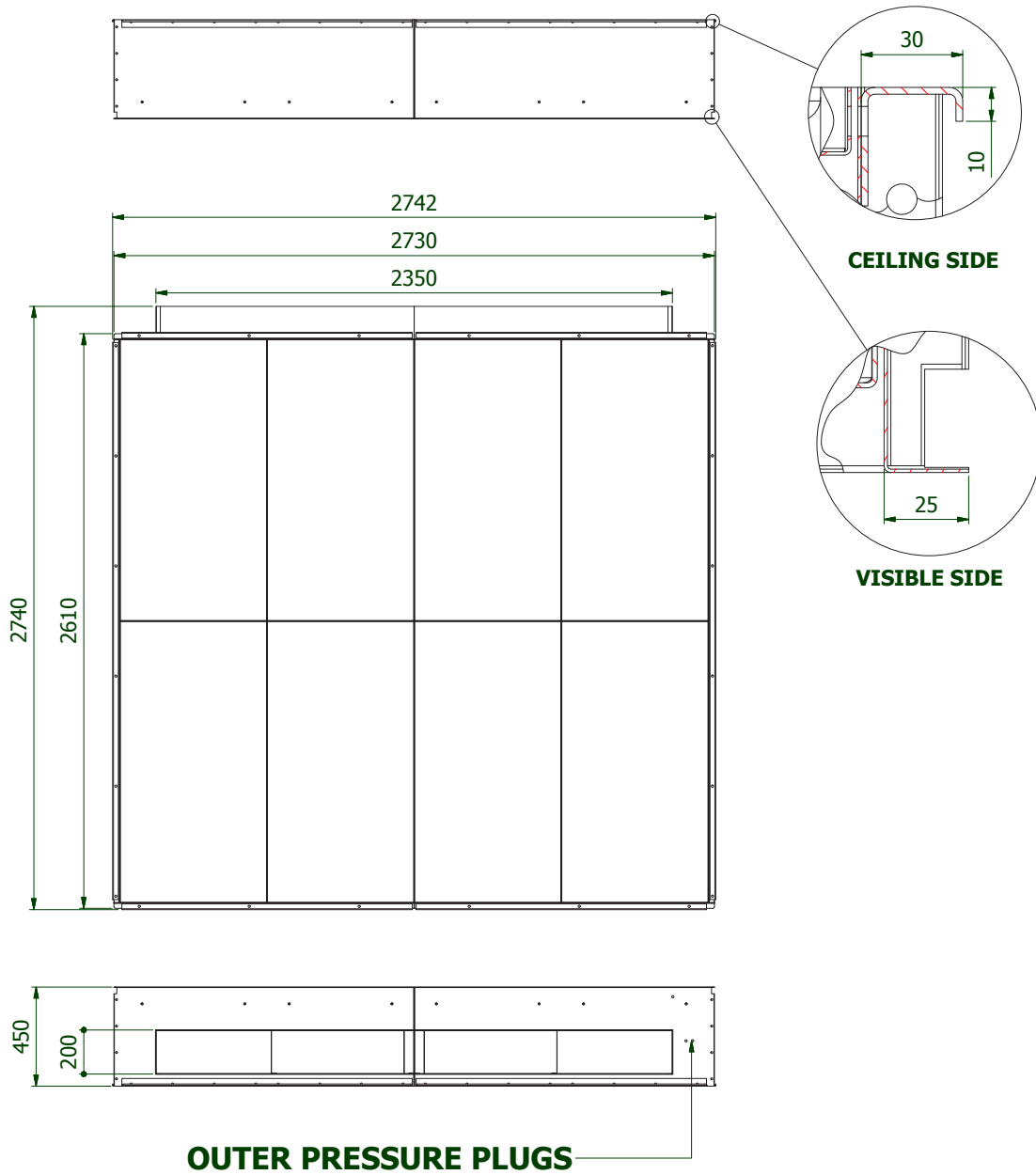

## EFPLA 8 DIMENSIONS

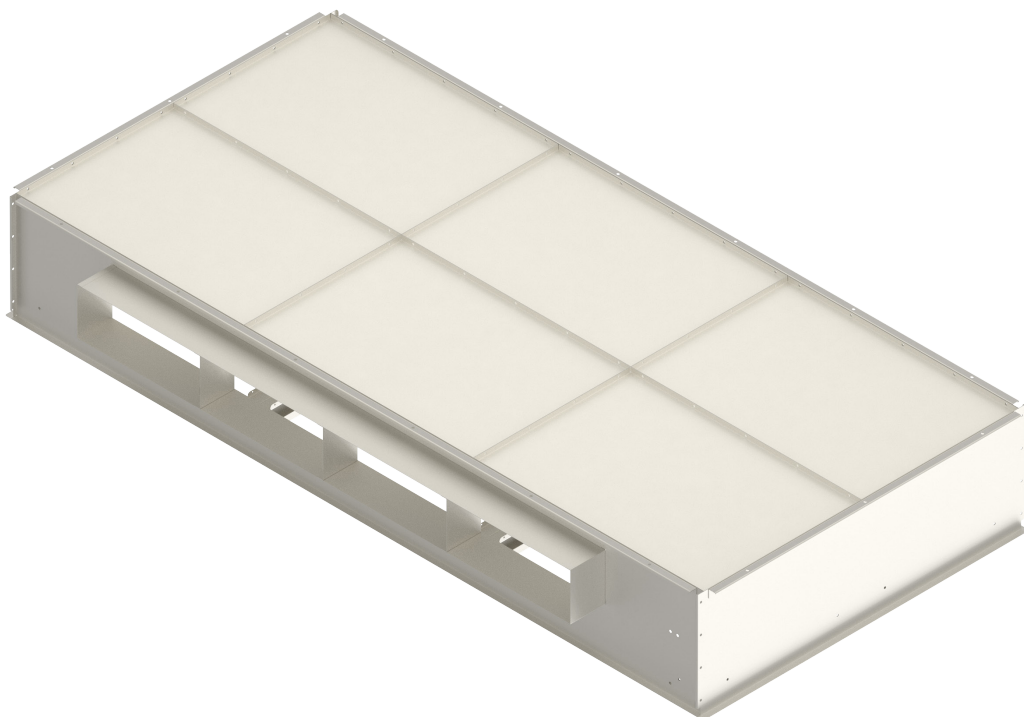
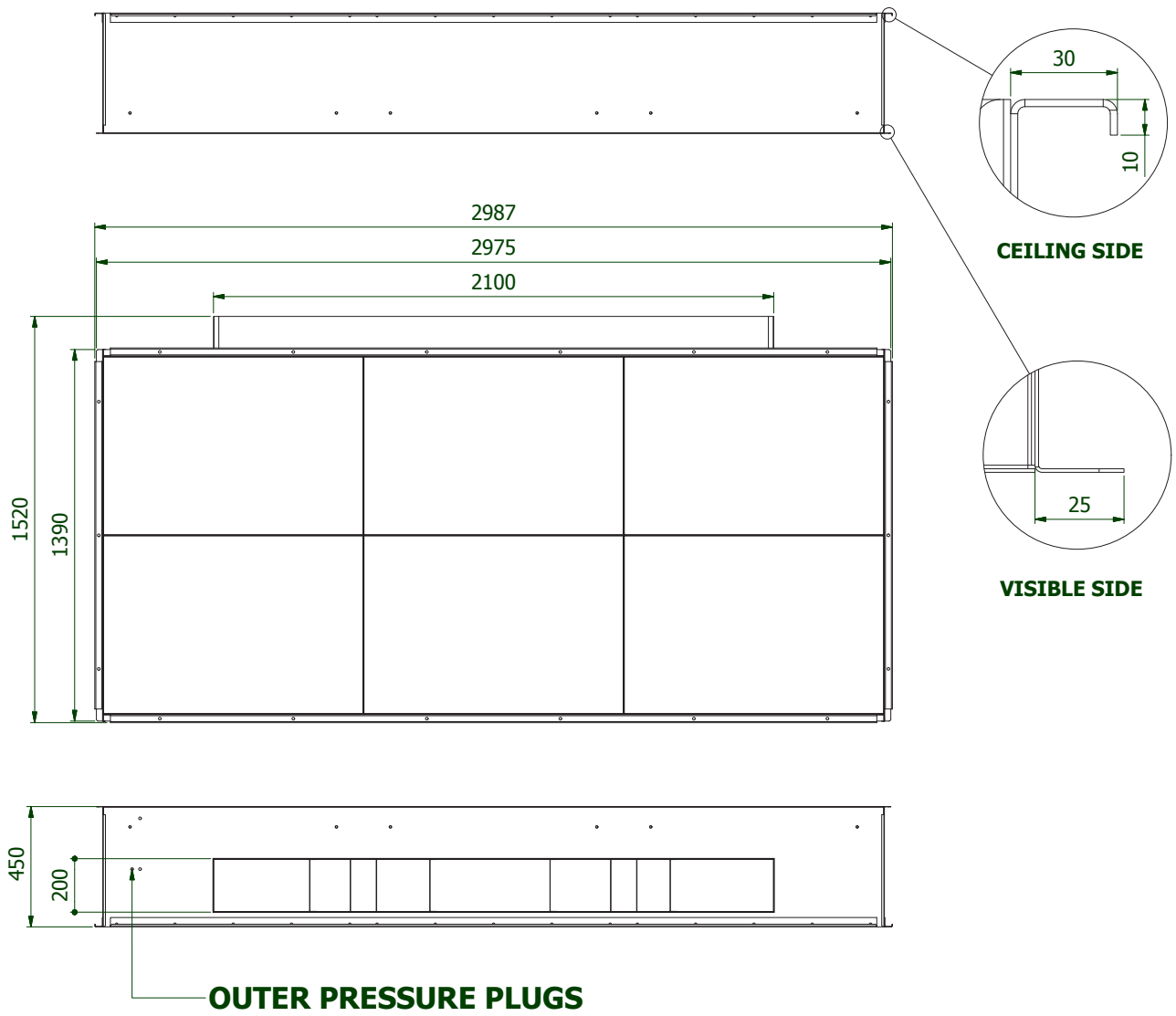

## EFPLA 9 DIMENSIONS

